

# Workshop on the use of automatic measuring systems on glaciers

Extended abstracts  
and recommendations

IASC Workshop, 23-26 March 2011,  
Pontresina (Switzerland)



Institute for Marine and Atmospheric Research,  
Utrecht University, the Netherlands





# **Workshop on the use of automatic measuring systems on glaciers**

**Extended abstracts and recommendations**

**IASC Workshop, 23-26 March 2011,  
Pontresina (Switzerland)**

**Organised by C.H. Tijm-Reijmer and J. Oerlemans**



Institute for Marine and Atmospheric Research  
Utrecht, Utrecht University, the Netherlands

ISBN: 978-90-39356555

# Contents

<b>Preface</b> . . . . .	<b>3</b>
<b>Program</b> . . . . .	<b>5</b>
<b>Posters</b> . . . . .	<b>8</b>
<b>Participants</b> . . . . .	<b>9</b>
<b>Workshop summary and recommendations</b> . . . . .	<b>11</b>
<i>C.H. Reijmer</i>	
<b>Abstracts</b> . . . . .	<b>16</b>
Automated monitoring of hydrochemistry above and below glaciers	17
<i>L. Bagshaw, J. Wadham, S. Burrow, M. Mowlem, M. Tranter, A. Fountain, C. Butler</i>	
Design and performance of the GEUS AWS . . . . .	22
<i>M. Citterio</i>	
Installing a high-altitude weather station network in the high Argentinean Andes . . . . .	27
<i>S.A. Crespo</i>	
AWS measurements on glaciers in the Italian Alps . . . . .	31
<i>G. Diolaiuti, A. Senese, C. Mihalcea, G.P. Verza, B. Mosconi and C. Smiraglia</i>	
WMO's Global Cryosphere Watch (GCW) and incorporation of <i>in-situ</i> Glacier Observations . . . . .	36
<i>B. Goodison</i>	
AWS measurements at the Belgian Antarctic station Princess Elisabeth, in Dronning Maud Land, for precipitation and surface mass balance studies . . . . .	40
<i>I.V. Gorodetskaya, N.P.M. van Lipzig, W. Boot, C. Reijmer, M.R. van den Broeke</i>	
High-elevation weather stations on glaciers in the Tropics - 2011 update . . . . .	45
<i>D.R. Hardy</i>	
Glacier Mass Balance Pods in Wireless Sensor Networks . . . . .	49
<i>J. Hulth and J. Strömbom</i>	
A versatile tower platform for glacier instrumentation: GPS and Eddy Covariance Measurements . . . . .	52
<i>A.H. Jarosch, F.S. Anslow, J. Shea</i>	
New AWS activities in Antarctica started by the Alfred Wegener Institute . . . . .	56
<i>B. Loose</i>	

Eddy covariance measurements on semi-arid Andean glaciers: power, memory and penitentes . . . . .	59
<i>S. MacDonell</i>	
Glaciological field studies at Zhadang Glacier (5500-6095 m), Tibetan Plateau . . . . .	62
<i>F. Maussion, Y. Wei, E. Huintjes, T. Pieczonka, D. Scherer, T. Yao, S. Kang, T. Bolch, M. Buchroithner and C. Schneider</i>	
Determining glacier velocity with single frequency GPS receivers . . . . .	69
<i>C.H. Reijmer, R.S.W. van de Wal and W. Boot</i>	
Recent technical developments at the IMAU: a new generation of AWS and wireless subglacial measurements . . . . .	73
<i>P. Smeets, W. Boot, M. van den Broeke, R. van de Wal</i>	
Using automatic weather station data to quantify snowmelt . . . . .	80
<i>M.R. van den Broeke, P. Smeets, C. Reijmer, W. Boot</i>	
GLACIOCLIM: a glacio-meteorological network to study the ablation processes over glaciers and snow covers . . . . .	84
<i>P. Wagnon, M. Litt, J.E. Sicart and Y. Lejeune</i>	
Ice-mounted masts as platforms for micro-meteorological measurements on glaciers . . . . .	88
<i>M. Winkler, R. Prinz, L. Nicholson, N. Cullen, C. Kinnard</i>	
Notes on AWS Measurements on the Kahiltna Glacier, Central Alaska Range, and a Simple Floating Temperature Stand Design . . . . .	92
<i>J. Young, A. Arendt and J. Hulth</i>	

# Preface

About 7 years ago Hans Oerlemans and I organized the 'Automatic Weather Stations (AWS) on glaciers' workshop. At that time the number of AWS deployed on glaciers had increased strongly and the glaciological community realised their importance for validation of models and satellite products. The extreme circumstances in which the AWS had to work were on the cutting edge of what was (and still is) technically possible.

Since then technology has advanced and glaciologists are still seeking the boundaries of the possibilities. The International Polar Year (IPY) 2007 gave polar research a push forward, resulting in a further increase in the number and the variety of in-situ observations on glaciers. This illustrates that there still is a need for more extensive and complete observational data sets, not only from standard meteorological quantities, but also from quantities related to e.g. snow characteristics and ice dynamics. Furthermore, in spite of our increased experience, the problems we face are still the same (e.g. power supply, communication, accessibility and equipment endurance), which is partly due to the fact that with advancing technology, the instrumentation deployed on glaciers became more complex.

In recent years people inquired when the next workshop will be organised. Now, two years after the IPY, it seemed a good moment to do so. With support from IASC we were able to organise a workshop focused on *in-situ* observations on glaciers. And so it happened that from 23 to 26 March 2011, 40 people gathered in the beautiful Swiss village Pontresina to share experiences and learn from each other. The meeting, consisting of short presentations, many discussions in coffee breaks and over dinner, and of course an excursion to the Morteratschgletscher, was generally found enjoyable, useful and inspiring.

Given the succes of the abstract book of the previous meeting, we decided that this meeting should also be summarised in a document. I hope that this collection of extended abstracts and recommendations will be useful to all of you, and especially to newcomers in the field. I also hope that it will remind the participants of the wonderful days in Pontresina.

Finally, I want to thank my co-convenor Hans Oerlemans for help and advise in organizing the workshop.

C.H. Tijm-Reijmer  
Convenor





# Program

## Wednesday 23 March

- 14:00 - 14:15 Welcome *Carleen Reijmer*
- 14:15 - 14:35 WMO Guidelines for Automation of Surface Observations  
*Miroslav Ondras*
- 14:35 - 14:55 The Importance of in-situ Glacier Observations in the Global Cryosphere Watch (GCW) *Barry Goodison*
- 14:55 - 15:25 Technology for autonomous monitoring and investigations of polar environments *Alberto Behar*
- 15:25 - 15:55 **Coffee break**
- 15:55 - 16:15 New AWS - activities in Antarctica started by the Alfred-Wegener-Institute *Bernd Loose*
- 16:15 - 16:35 AWS measurements at the Belgian Antarctic station Princess Elisabeth, Dronning Maud Land *Irina Gorodetrkaya, N. van Lipzig, M. van den Broeke, W. Boot, C. Reijmer and A. Mangold*
- 16:35 - 16:55 Quantifying melt energy from IMAU AWS in Antarctica and Greenland *Michiel van den Broeke, W. Boot, C. Reijmer, P. Smeets, P. Kuipers Munneke, R. van de Wal and J. Oerlemans*
- 16:55 - 17:15 High-elevation weather stations on glaciers in the Tropics, continued *Douglas Hardy*
- 17:15 - 17:35 On hose clamps and electric tape – eight years of maintaining a low-budget AWS network on McCall Glacier, arctic Alaska *M. Nolan, Douglas Hardy*
- 17:35 - 18:00 **POSTER SESSION**

## Thursday 24 March

- 08:30 - 08:45 Automatic Weather Stations in the Cordillera Blanca (Peruvian Andes) *Martin Großhauser and S. Galos*
- 08:30 - 08:45 Innsbruck Tropical Glaciology Group East African AWSs *R. Prinz, L. Nicholson, Michael Winkler, N. Cullen, G. Kaser and T. Mölg*
- 09:00 - 09:20 24 weather stations on Greenland, 25 things to go haywire *Dirk van As, S. Nielsen, A. Ahlstrøm, S.B. Andersen, M.L. Andersen, M. Citterio, R.S. Fausto and F.M. Nick*

- 09:20 - 09:40 Internals and performance of the GEUS automatic weather stations *Michele Citterio*
- 09:40 - 10:00 Autonomous AWS and GPS observations at Helheim Glacier, East Greenland *Morten L. Andersen, M. Nettles, P. Elósegui, J.L. Davis, G.S. Hamilton, E. Malinkowski, I. Gonzalez, M. Okal and B. Johns*
- 10:00 - 10:30 Introduction to the excursion to the Vadret da Morteratsch *Hans Oerlemans*
- 12:00 - 16:30 **EXCURSION**

## Friday 25 March

- 08:30 - 09:00 Recent developments at the IMAU: a new AWS generation & wireless subglacial measurements *Paul Smeets, W. Boot, M. van den Broeke and R. van de Wal*
- 09:00 - 09:20 Glaciological field studies at Zhadang Glacier, Tibet *Fabien Maussion*
- 09:20 - 09:40 Glacioclim, a glacio-meteorological network to study ablation processes over glaciers and snow covers *Patric Wagnon, J.E. Sicart, Yves Lejeune*
- 09:40 - 10:00 Installing a network of high altitude weather stations in the argentinean Andes *Sebastian Andres Crespo*
- 10:00 - 10:20 Automatic measurements of glaciers in the Arid Andes of Chile *Lindsey Nicholson, C. Kinnard, A. Cordero, A. Rabatel, H. Castebrunet, V. Favier, S. MacDonell, R. Garrido, J. Marín, R. Ponce, J.L. Castro and J. Araos*
- 10:20 - 10:50 **Coffee break**
- 10:50 - 11:10 Eddy covariance measurements on semi-arid Andean glaciers: power, memory and penitentes *Shelley MacDonell*
- 11:10 - 11:30 A versatile tower platform for glacier instrumentation: e.g. GPS and Eddy Covariance Measurements *Alex H. Jarosch, F.S. Anslow, J.M. Shea*
- 11:30 - 11:50 Using single frequency GPS receivers to determine glacier velocities *Carleen Reijmer and W. Boot*
- 11:50 - 12:10 IceMole: An Autonomous Probe for Research in Ice *Engelbert Plescher*
- 12:10 - 12:30 Using geomatic techniques for glacier monitoring in the Pyrenees *Ibai Rico Lozano, E. Serrano, M.J. González Amuchastegui, J.J. de San José and J. Matias*

12:30 - 14:00 **Lunch**

14:00 - 14:20 Observing glacier processes with time-lapse photography  
*Hans Oerlemans*

14:20 - 14:40 Monitoring hydrochemistry above and below glaciers (in Greenland and the Antarctic) *Liz Bagshaw, J. Wadham, S. Burrow, M. Mowlem, M. Tranter and A. Fountain*

14:40 - 15:00 Effects of soot, algae, and mineral dust on the albedo of the Plaine Morte Glacier, Switzerland *Margit Schwikowski, E. Bühlmann, P.-A. Herren*

15:00 - 15:20 AWS measurements on the Kahiltna Glacier, Central Alaska Range, USA *Joanna Young, A. Arendt, R. Hock, R. Motyka, S. Herreid, J. Hulth*

15:20 - 15:50 Automated ablation measurements using a pressure transducer *Robert S. Fausto*

15:50 - 16:00 Conclusions *Carleen Reijmer*



**Photo:** The Morteratsch glacier in 2004 (top) and 2011 (bottom).

# Posters

- IMAU Automatic Weather Stations *Wim Boot*
- IMAU European Automatic Weather Stations *Wim Boot*
- iWS-5: A new 2012 generation of low temperature, rapid deployment weather stations *Wim Boot*
- AWS measurements on glaciers in the Italian Alps *G. Diolaiuti, Antonella Senese, C. Mihalcea, G.P. Verza, M. Mosconi and C. Smiraglia*
- The 'ablation stakes' of the 21st century: Glacier Mass Balance Pods in a Wireless Sensor Network *John Hulth and J. Strömbom*
- AWS measurements on debris-covered glaciers in the Karakoram *Claudia E. Mihalcea, E. Vuillermoz, G. Diolaiuti, G. Verza, C. Mayer, A. Lambrecht and C. Smiraglia*
- Cryospheric monitoring Sonnblick-Pasterze, Austria: Instruments and methods *Gernot Weyss, W. Schöner, B. Hynek, R. Böhm, D. Binder, S. Reisenhofer, M. Olefs and R. Unger*



**Photo:** The Rondo convention centre in Pontresina, Switzerland.

# Participants

1. Morten Langer Andersen ([morten.langer@gmail.com](mailto:morten.langer@gmail.com))
2. Liz Bagshaw\* ([liz.bagshaw@bristol.ac.uk](mailto:liz.bagshaw@bristol.ac.uk))
3. Alberto Behar ([alberto.e.behar@jpl.nasa.gov](mailto:alberto.e.behar@jpl.nasa.gov))
4. Gerit Birnbaum ([Gerit.Birnbaum@awi.de](mailto:Gerit.Birnbaum@awi.de))
5. Wim Boot ([W.Boot@uu.nl](mailto:W.Boot@uu.nl))
6. Eva Bühlmann
7. Michele Citterio ([mcit@geus.dk](mailto:mcit@geus.dk))
8. Sebastian Andres Crespo ([screspo@mendoza-conicet.gob.ar](mailto:screspo@mendoza-conicet.gob.ar))
9. Robert Fausto ([rsf@geus.dk](mailto:rsf@geus.dk))
10. Stephan Galos ([Stephan.Galos@student.uibk.ac.at](mailto:Stephan.Galos@student.uibk.ac.at))
11. Barry Goodison ([barrygo@rogers.com](mailto:barrygo@rogers.com))
12. Irina Gorodetrkaya\* ([Irina.Gorodetskaya@ees.kuleuven.be](mailto:Irina.Gorodetskaya@ees.kuleuven.be))
13. MartinGroßhauser ([mgroszhauser@gmail.com](mailto:mgroszhauser@gmail.com))
14. Doug Hardy ([dhardy@geo.umass.edu](mailto:dhardy@geo.umass.edu))
15. Pierre-Alain Herren
16. John Hulth\* ([john.hulth@umb.no](mailto:john.hulth@umb.no))
17. Alexander Jarosch ([Alexander.Jarosch@uibk.ac.at](mailto:Alexander.Jarosch@uibk.ac.at))
18. Michael Kuhn ([Michael.Kuhn@uibk.ac.at](mailto:Michael.Kuhn@uibk.ac.at))
19. Yves Lejeune ([yves.lejeune@meteo.fr](mailto:yves.lejeune@meteo.fr))
20. Jan Lenaerts\* ([J.Lenaerts@uu.nl](mailto:J.Lenaerts@uu.nl))
21. Bernd Loose ([bernd.loose@awi.de](mailto:bernd.loose@awi.de))
22. Shelley MacDonell ([shelley.macdonell@gmail.com](mailto:shelley.macdonell@gmail.com))
23. Tom Matthews\* ([T.K.R.Matthews@lboro.ac.uk](mailto:T.K.R.Matthews@lboro.ac.uk))
24. Fabien Maussion ([fabien.maussion@tu-berlin.de](mailto:fabien.maussion@tu-berlin.de))
25. Claudia Mihalcea ([claudia.mihalcea@unimi.it](mailto:claudia.mihalcea@unimi.it))
26. Lindsey Nicholson ([linznix@gmail.com](mailto:linznix@gmail.com))
27. Faezeh Nick ([Faezeh.Nick@ulb.ac.be](mailto:Faezeh.Nick@ulb.ac.be))
28. Søren Nielsen ([sn@geus.dk](mailto:sn@geus.dk))
29. Matt Nolan ([web@drmattnolan.org](mailto:web@drmattnolan.org))
30. Hans Oerlemans ([J.Oerlemans@uu.nl](mailto:J.Oerlemans@uu.nl))
31. Miroslav Ondras ([MOndras@wmo.int](mailto:MOndras@wmo.int))
32. Engelbert Plescher ([plescher@fh-aachen.de](mailto:plescher@fh-aachen.de))
33. Rainer Prinz ([Rainer.Prinz@uibk.ac.at](mailto:Rainer.Prinz@uibk.ac.at))
34. Ibai Rico Lozano\* ([ibaiurki@yahoo.es](mailto:ibaiurki@yahoo.es))
35. Margit Schwikowski ([margit.schwikowski@psi.ch](mailto:margit.schwikowski@psi.ch))
36. Antonella Senese ([antonella.senese@unimi.it](mailto:antonella.senese@unimi.it))
37. Jean Emmanuel Sicart ([jean-emmanuel.sicart@ird.fr](mailto:jean-emmanuel.sicart@ird.fr))
38. Paul Smeets ([C.J.P.P.Smeets@uu.nl](mailto:C.J.P.P.Smeets@uu.nl))
39. Carleen Tijm-Reijmer ([C.H.tijm-Reijmer@uu.nl](mailto:C.H.tijm-Reijmer@uu.nl))
40. Dirk van As ([dva@geus.dk](mailto:dva@geus.dk))

41. Michiel van den Broeke ([m.r.vandenbroeke@uu.nl](mailto:m.r.vandenbroeke@uu.nl))
42. Patric Wagnon ([wagnon@lgge.obs.ujf-grenoble.fr](mailto:wagnon@lgge.obs.ujf-grenoble.fr))
43. Gernot Weyss ([G.Weyss@zamg.ac.at](mailto:G.Weyss@zamg.ac.at))
44. Michael Winkler ([Michael.Winkler@uibk.ac.at](mailto:Michael.Winkler@uibk.ac.at))
45. Joanna Young\* ([joanna.young@gi.alaska.edu](mailto:joanna.young@gi.alaska.edu))

(Young scientists receiving support are marked \*).



**Photo:** The participants on the Morteratsch glacier.

# Workshop summary and recommendations

Carleen H. Reijmer

Utrecht University, Institute for Marine and Atmospheric research Utrecht, The Netherlands.

## Introduction

Automated systems that measure the energy and mass budget, and dynamics of glaciers have been deployed for some decades now. Designing and operating these systems involves the challenge of obtaining continuous and reliable data from unattended sites in extreme environments. To discuss these challenges and share experiences, the *IASC workshop on the use of automatic measuring systems on glaciers* took place in March 2011 in Pontresina, Switzerland. This workshop succeeded the *Automatic Weather Stations (AWS) on glaciers* workshop held in 2004, of which results were published in [Reijmer \(2004\)](#). The present workshop again brought together an international group of researchers, and this document summarizes some of the discussions, identifies remaining challenges and provides some recommendations.

## Focus and discussed topics

The 2004 workshop focused on the deployment of AWS on glaciers. Although AWS still represent a core activity in glaciological field observations, the extension towards ice dynamics (velocity, deformation) in combination with technical progress has opened up numerous new study areas. The topic of the 2011 meeting, as reported in this volume, was therefore a more general one, namely automated measuring systems on glaciers.

A variety of topics was discussed in the meeting, ranging from comparing different types of instrumentation for the same goal, geographical and logistical challenges, power and communication issues. About two thirds of the presentations dealt with weather stations and mass balance observations, the other presentation topics ranged from glacier velocity observations using GPS, the (im)possibilities of time lapse photography, how to measure sub- and englacial properties, and chemical and biological observations.

An overview of discussed topics and recommendations is given below. Pers. comm. refers to either a presentation or discussion at the meeting.

## Automatic Weather Stations

Several weather station mast designs are currently in use, see e.g. Diolaiuti et al. (p. 31), Gorodetskaya et al. (p. 40), Hardy (p. 45) and Young

et al. (p. 92). The 'floating' system is well accepted on melting glaciers, but is not very useful on glaciers with very rough terrain, e.g. glacier surfaces covered by penitentes (MacDonell (p. 59)), or with large accumulation rates. The floating systems have either 3 or 4 legs, and some have wooden plates to prevent freezing in. A disadvantage of the wooden plates is that the station may start sliding on undulated ice surfaces (Van As, pers. comm.). Freezing of the legs may stabilize the station from sliding, but it also changes the instrument height somewhat. A special design is the Innsbruck system which uses cardan-like joints to keep the instruments horizontal (Prinz et al., pers. comm.). Designs with one or more extendable poles drilled in the ice may be suitable for accumulation areas, but can cause stability problems in ablation areas. During the meeting two modular systems of this type were presented (Jarosch et al., p. 52, and Winkler et al., p. 88).

New developments in AWS datalogger design were presented by Citerio (p. 22) and Smeets et al. (p. 73). Both were incited by the recent change from Campbell CR10X to Campbell CR1000 data loggers. Both new developments emphasize the importance of low power demand and reliable communication. Sensor choice is an important part of the AWS design. Several authors list and discuss their choices (e.g. Maussion et al., p. 62 and Loose, p. 56). Besides the standard meteorological parameters such as temperature, humidity, wind and pressure, for glacier surfaces it is generally accepted that the four radiation components must be measured as well. The type/manufacturers may vary depending on experience, (power) demands and not in the least funding. Power supply and instrument choice is closely linked when e.g. choosing the air temperature sensor in combination with a radiation screen. Although it is recognized that continuous ventilation is best, several authors discuss different ventilation strategies (Hardy, p. 45, and Maussion et al., p. 62). Illustrating limitations set by funding, an extreme case was presented by Nolan and Hardy (pers. comm.). They showed how discarded stakes, tape and hose clamps can start a new life as a weather station mast.

For an extensive list of recommendations regarding AWS observations, the reader is referred to [Box et al. \(2004\)](#); their conclusions are still valid and can be applied on other automated systems as well. In this volume, several authors present the lessons they learned and their own recommendations, see e.g. Hardy (p. 45) who presents his list that complements [Box et al. \(2004\)](#).

### **Mass balance**

There are several different designs to measure mass balance. Traditionally, stakes and sonic height rangiers are used. New ways to measure ablation include systems using a mass on a wire (Hulth et al., p. 49), and measuring pressure differences in fluid filled hoses (Fausto, pers. comm.). Both systems have the advantage not to sink in the ice as stakes may do, and can be combined with a sonic altimeter to measure accumulation.



Both systems can also be operated unattended for several years in high ablation areas. At present the wire system is in a test phase and shows great promise. The Geological Survey of Denmark and Greenland (GEUS) manages to successfully operate a system with fluid filled hoses. For all these systems, knowledge of the density is still necessary to determine the mass of melted/accumulated ice/snow.

### **Power supply**

Power supply presents a recurring challenge and arguably is the most important issue besides station design and instrumentation. Batteries, solar panels and wind generators can all be problematic when moisture enters the system, during polar nights without solar radiation, or when snow covers solar panels and during extreme wind events. Questions raised were 'what are the best batteries to use' and 'how to regulate charging of the batteries by solar or wind energy'. Of course the type of power supply is very much defined by the station design and the instruments it has to power. For example, the E-tracers and GPSs described by Bagshaw et al. (p. 17) and Reijmer et al. (p. 69), resp., work on a single lithium battery, while Citterio (p. 22) describes a complex system of batteries and solar panels to operate an AWS. Finding the best power setup is not easy as shown by MacDonell et al. (p. 59) who tested different combinations of batteries and solar panels in order to run their station for longer periods.

### **Communication**

Different communication techniques are used, particularly the Argos (see e.g. Gorodetskaya et al., p. 40, Reijmer et al., p. 69, and Smeets et al., p. 73) and Iridium satellite systems (see e.g. Citterio, p. 22, and Hulth et al., p. 49), but also Inmarsat satellite system, GSM, radio communication and Bluetooth. All have advantages and disadvantages related to power demands, costs involved, distance over which can be communicated, amount of data that can be transferred, one or two way communication possibilities, and future prospects of the system. For example, the Argos system is very reliable but is expensive and limited in the amount of data to be transferred, and only data retrieval is possible. Iridium, Inmarsat and the GSM system have two way communication possibilities but are more power demanding, with the latter two having limited communication ranges. Radio communication is only used for short line of sight distances while Bluetooth is used in the new IMAU development (Smeets et al., p. 73) for in-station and station-to-laptop communication. In general new measuring systems are mostly using the Iridium satellite system (Behar, pers. comm.).

### **Subsurface observations**

Subsurface observations are a new development in glaciological research. The challenge is to design a system that can withstand the high pressure from a large water or ice column, and retrieve the data either by

wireless communication or by retrieving the system itself. Bagshaw et al. (p. 17) present a small system, the E-tracer, that flows through the sub-glacial drainage system. The E-tracer has to be retrieved after it leaves the drainage system of the glacier. 20% of the deployed sensors are retrieved and a multitude of sensors must be put into the system. Smeets et al. (p. 73) present a system to be put into a hole where it will freeze and send its data wireless to the surface. Both systems are still in the developmental stage but show promise in retrieving continuous data sets from inside and/or beneath ice masses.

### **Geographical considerations**

The geographical areas discussed in the meeting cover the whole globe: from Greenland to Antarctica, and Alaska to the Andes, the Alps and Tibet. The variety of locations showed that different settings result in different problems, not only technical. Issues related to location are mainly meteorological (snowfall and melt amount, surface roughness e.g. penitentes, high altitude, low temperatures, wind regime) or logistical such as accessibility of the measurement site on foot, by snow mobile, car or helicopter. But part of the geographical considerations are social issues, e.g. acceptance of the local population of the activities. Damaging and theft of equipment occurs, as well as people showing genuine interest and providing a helping hand (Maussion et al., p. 62).

### **Data**

The goal of all these efforts is to obtain uninterrupted and long datasets. With the many years of experience we now have, there are several datasets for different parameters and parts of the globe. Especially during the IPY, effort has been put in creating web interfaces, internet databases and networks in order to aid in the data availability. This also raised the issue of standardization. Especially in the field of operating Automatic Weather Stations there is a need for standardization, i.e. to define the 'ideal' weather station. This includes making available information about performance of different brand instruments under extreme conditions, comparison of power and communication systems, as well as data treatment such as presented by Gorodetskaya et al. (p. 40) and Van den Broeke et al. (p. 80). With the increased amount and type of observations, came the wish to coordinate observations in networks, such as presented by Wagnon et al. (p. 84) and Crespo (p. 27), and super-sites. WMO is very much interested in these issues (Ondras, pers. comm., and Goodison, p. 36).

### **Conclusions**

The discussions about the issues summarized above did not result in one simple answer, but in this booklet. It became clear that the choices made

and presented by researchers and research groups depend mainly on geographical and meteorological setting in combination with available funds. Recommendations of individual researchers can be found in their abstracts.

In this workshop it was shown that important developments in different kinds of equipment used on glaciers have taken place. Especially noteworthy is the development in performing subglacial measurements, although still limited to wireless pressure and temperature measurements. On the other hand some issues remain unsolved. E.g. to this date there is no system available to automatically measure snow density on glaciers.

With the increased number and variety of observations on glaciers, the need for exchange of technical knowledge becomes more important. In order for groups that just start in the field of glacial research not to make the same mistakes that others made, the availability of technical information is important. This book of extended abstracts and recommendations may help to achieve that goal.

## References

- Box, J., P. Anderson and M. R. van den Broeke. 2004. Lessons to be learned. In: Reijmer, C., editor, *Automatic weather stations on glaciers*, Workshop proceedings, pages 9–28. Institute for Marine and Atmospheric Research Utrecht (IMAU).
- Reijmer, C., editor. 2004. *Automatic weather stations on glaciers: Lessons to be learned and extended abstracts*. Institute for Marine and Atmospheric Research Utrecht (IMAU). pp. 115.  
[http://www.projects.science.uu.nl/iceclimate/workshop/documents/aws\\_abstracts.pdf](http://www.projects.science.uu.nl/iceclimate/workshop/documents/aws_abstracts.pdf).

# Abstracts

# Automated monitoring of hydrochemistry above and below glaciers

Liz Bagshaw<sup>1,2</sup>, Jemma Wadham<sup>1</sup>, Steve Burrow<sup>2</sup>, Matt Mowlem<sup>3</sup>, Martyn Tranter<sup>1</sup>, Andrew Fountain<sup>4</sup>, Catie Butler<sup>1</sup>

<sup>1</sup> Bristol Glaciology Centre, School of Geographical Sciences, University of Bristol, Bristol BS8 1SS UK,

Email: Liz.Bagshaw@bristol.ac.uk

<sup>2</sup> Queens School of Engineering, University of Bristol, University Walk, Bristol BS8 1TR UK,

<sup>3</sup> National Oceanography Centre, University of Southampton, UK,

<sup>4</sup> Departments of Geology and Geography, Portland State University, USA

Glacier meltwater hydrochemistry is an increasingly important parameter in glacier monitoring. The hydrochemical signature of meltwater can yield a variety of information, including the nature of the flowpaths of water beneath the glacier, how long the water has been in contact with the glacier bed, and if any biological activity has occurred. Historically, this have been achieved via diurnal sampling of the main glacier outflow for discharge, electrical conductivity (EC) (Collins, 1979; Sharp *et al.*, 1995) and later, for pH, major anions and cations (Wadham *et al.*, 1998; Tranter *et al.*, 2002) and dissolved oxygen (DO) (Hodson, 2006). Glacier surface melt bodies, including supraglacial lakes, cryolakes and cryoconite holes also undergo biogeochemical fluctuations associated with physical changes and biological activity, and these have predominantly been monitored through point sampling (Tranter *et al.*, 2004; Bagshaw *et al.*, 2007), remotely sensed snapshots (Bartholomew *et al.*, 2011) or field/laboratory simulation (Anesio *et al.*, 2009).

These sampling methods have significantly increased our understanding of the processes that are occurring in glacier surface ecosystems, and in subglacial environments. However, diurnal or point sampling is liable to miss key events that occur during the melt season; for example, subglacial outburst events or short-term supraglacial freeze-thaw cycles, and inferences about the subglacial drainage system are hampered by a lack of in situ measurements. Therefore, there is an increasing need for longer-term, continuous datasets, and the ability to collect data beneath ice masses. Current monitoring techniques are frequently unsuitable for this purpose; for example, Clarke electrodes for monitoring DO require constant stirring or water motion (Bagshaw *et al.*, 2010) which is not possible in many surface melt features. New sensors or adaptation of existing sensors is thus required to fully capture melting and freezing processes and the subsequent biogeochemical changes that occur on the surface and beneath glaciers. This short summary discusses progress to date and outlines future research towards these aims.

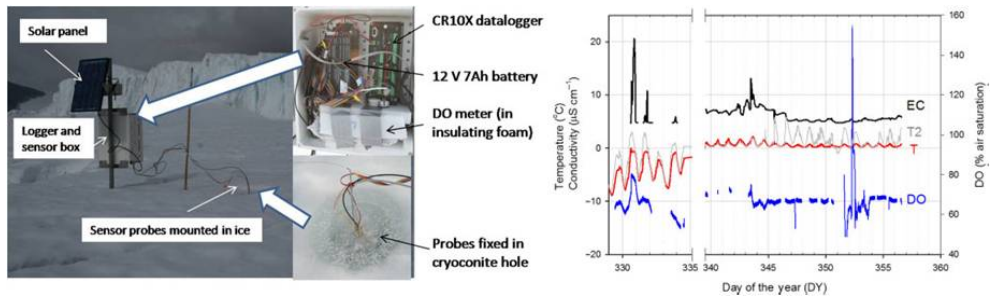

**Figure 1.** Fibre optic sensors for dissolved oxygen installed in a cryoconite hole on the surface of Canada Glacier, McMurdo Dry Valleys, Antarctica. The sensor was wrapped in insulating material and external heat packs were applied to prolong operation in cold temperatures. The data series from the experiment revealed a large DO excursion within the hole associated with freeze-thaw cycling.

### On Glaciers: High resolution monitoring of cryoconite hole processes

Fibre optic sensors for dissolved oxygen (PreSens) were used in conjunction with EC and temperature probes and a Campbell CR10X datalogger on the surface of Canada Glacier, McMurdo Dry Valleys, Antarctica to monitor freeze-thaw events in a cryoconite hole during the ablation season (Bagshaw *et al.*, 2011). Figure 1 shows the sensor setup in the Austral summer of 2008/9, and the resulting dataset. The sensors were deployed for 4 weeks, but did not operate continuously in the cold. With the application of external heat packs, a near continuous dataset was recorded in the later part of the deployment, including an interesting DO excursion associated with a freeze-thaw event (Fig. 1). The rapid increase in DO is thought to be a result of freeze-squeezing of the air-filled headspace within the cryoconite hole. As the water at the edges of the hole freezes when air temperatures drop below zero, the headspace is reduced in size and hence gases, including oxygen, are forced into the remaining liquid water. This drives a rapid increase in DO associated with freezing, even though the centre of the hole remains liquid. The experiment was repeated in the same location the following year, with an additional site on the Garwood Glacier in the Garwood Valley. A thermostatically-controlled electric heat blanket was used to warm the sensors during the coldest period, which enabled continuous data collection. Similar freeze-thaw excursions were recorded, and the same freeze-thaw event was simultaneously captured by the sensors in Taylor and Garwood Valleys.

In addition, the sensors were deployed in open, hydrologically connected cryoconite holes 17 km from the margin of Leverett Glacier, Greenland, in the summer of 2010, in conjunction with sensors (Apogee) for photosynthetically available radiation (PAR) on the ice surface and at the base of the cryoconite holes. The lack of an ice covering on the open cryoconite holes means that gas exchange between the water and the atmosphere is unimpeded, but the dataset nevertheless shows evidence of biogeochemical changes associated with physical conditions on the ice



**Figure 2.** An electronic tracer (E-Tracer) for subglacial pressure sensing. The sensor package incorporates a radio chip which emits a signal to allow retrieval once the sensor has passed through the subglacial drainage system. The white potting mixture means that the sensor is neutrally buoyant, and the spherical shape allows it to pass through tortuous drainage conduits. The bright colour aids retrieval from the proglacial stream.

surface. The most significant finding was that the holes drain rapidly in conjunction with larger scale drainage events. The timing of the cryoconite hole drainage was coincident with the drainage of large supraglacial lakes at 800 - 1000 m a.s.l. (Bartholomew *et al.*, 2011), which prompted a subglacial outburst event (Butler, unpublished data).

### **Beneath Glaciers: high resolution bulk meltwater hydrochemistry and in situ subglacial measurements**

The bulk meltwater chemistry was monitored for such outburst events from May to August 2010, using a high resolution sensor array for EC, pH, DO, turbidity, water temperature and discharge which sampled every 30s and took an average every 10 minutes. The array was solar powered, and controlled by a Campbell CR10X datalogger, backed up by a storage module. The sensor array was supported by a high frequency meltwater sampling regime measuring major ions, dissolved nutrients and other parameters for the detection of biological activity (Butler, unpublished data). The EC record detected several outburst events over the season (Bartholomew *et al.*, 2011), and the biogeochemical data showed the likely source of the water for each event. For example, high levels of DO in the meltwater were indicative of the drainage of a supraglacial lake.

Bulk meltwater measurements are valuable for assessing potential water flowpaths through the glacier; however, in situ measurements can provide a more detailed picture of conditions at the glacier bed. To this aim, the University of Bristol is developing a range of electronic sensors (E-Tracers) that travel through the subglacial drainage system collecting data, and are then be retrieved at the glacier portal via radio direction finding. The E-Tracer package comprises a small (50 mm), neutrally buoyant sensor platform including a microprocessor (PIC), internal datalogger (EEPROM) and a radio chip (Radiometrix) which emits a radio signal (Fig. 2). They are powered by a 0.5 AA size lithium battery. The sensor package is adaptable,

but has been tested with a temperature sensor (Leverett Glacier, Greenland, 2009) and a pressure sensor (Leverett Glacier, Greenland, 2010). The sensors are deployed into a moulin and allowed to flow through the subglacial drainage system. Their small size and spherical shape aids progress through the often tortuous flowpaths, and a proportion emerge at the drainage portal. They are detected via radio direction finding and retrieved. The stored data is downloaded via serial output to a datalogger. Approximately 20% of the deployed sensors were retrieved; sensor loss was anticipated and was a factor which determined the low cost of the E-Tracers (approximately 25 GBP). Additional deployments of the pressure measuring E-Tracer are planned for summer 2011 at the Leverett Glacier, and an enhanced sensor package including EC and an accelerometer is in development for summer 2012.

## Conclusions

High resolution, automated monitoring techniques have been adapted to monitor glacier meltwater hydrochemistry on the surface of glaciers in Antarctica and Greenland, and have revealed previously unobserved relationships between physical processes and biogeochemical conditions in cryoconite holes. High frequency monitoring of glacier meltwater hydrochemistry via sensor arrays shows links between surface hydrology and subglacial outburst events. In situ measurements of subglacial water pressure have been collected using innovative E-Tracers, which travel through the drainage system and are retrieved via radio direction finding. Continued development of similar sensors will enhance understanding of the processes occurring beneath the bed of glaciers, particularly links between surface melting and basal hydrology at the margins of the Greenland ice sheet.

## Acknowledgements

This work was supported by NERC grant NE/H023879/1, EPSRC grant EP/D057620/1 and NSF grant ANT-0423595. Antarctic fieldwork was conducted with the MCMDV LTER site team and Antarctica New Zealand, whose support is gratefully acknowledged, with logistics provided by Raytheon Polar Services and PHI Helicopters. Greenland fieldwork was conducted with the support of Kangerlussuaq International Science Support and HeliGreenland.

## References

- Anesio, A., A. Hodson, A. Fritz, R. Psenner and B. Sattler. 2009. High microbial activity on glaciers: Importance to the global carbon cycle. *Global Change Biology*, **15**(4), 955–960. Doi: 10.1111/j.1365-2486.2008.01758.x.
- Bagshaw, E., M. Tranter, A. Fountain, K. Welch, H. Basagic and W. Lyons. 2007. Biogeochemical evolution of cryoconite holes on Canada glacier, Taylor Valley, Antarctica. *J. Geophys. Res.*, **112**(G4). Doi: G04s35 10.1029/2007jg000442.
- Bagshaw, E., J. Wadham, M. Mowlem, J. Eveness, A. Fountain, M. Tranter and J. Telling. 2010. Determination of dissolved oxygen in the cryosphere: A comprehensive laboratory and field evaluation of fibre optic sensors. *Environ. Science and Technol.* Doi: 10.1021/es102571j.



- Bagshaw, E., M. Tranter, J. Wadham, A. Fountain and M. Mowlem. 2011. High resolution monitoring reveals dissolved oxygen dynamics in an antarctic cryoconite hole. *Hydrol. Process.* Doi: 10.1002/hyp.8049.
- Bartholomew, I., P. Nienow, A. Sole, D. Mair, T. Cowton, S. Palmer and J. Wadham. 2011. Supraglacial forcing of subglacial drainage in the ablation zone of the greenland ice sheet. *Geophys. Res. Lett.*, **38**(L08502). Doi: 10.1029/2011GL047063.
- Collins, D.. 1979. Hydrochemistry of meltwaters draining from an alpine glacier. *Arctic and Alpine Research*, **11**(3), 307–324.
- Hodson, A.. 2006. Biogeochemistry of snowmelt in an antarctic glacial ecosystem. *Water Resour. Res.*, **42**. Doi: 10.1029/2005WR004311.
- Sharp, M., G. Brown, M. Tranter, I. Willis and B. Hubbard. 1995. Comments on the use of chemically based mixing models in glacier hydrology. *J. Glaciol.*, **41**(138), 241–245.
- Tranter, M., M. Sharp, H. Lamb, G. Brown, B. Hubbard and I. Willis. 2002. Geochemical weathering at the bed of haut glacier d'arolla, switzerland - a new model. *Hydrol. Process.*, **16**(5), 959–993.
- Tranter, M., A. Fountain, C. Fritsen, W. Lyons, J. Priscu, P. Statham and K. Welch. 2004. Extreme hydrochemical conditions in natural microcosms entombed within antarctic ice. *Hydrol. Process.*, **18**(2), 379–387.
- Wadham, J., A. Hodson, M. Tranter and J. Dowdeswell. 1998. The hydrochemistry of meltwaters draining a polythermal-based, high arctic glacier, south svalbard: I. the ablation season. *Hydrol. Process.*, **12**(12), 1825–1849.

# Design and performance of the GEUS AWS

Michele Citterio

Dept. of Marine Geology and Glaciology, GEUS - Geological Survey of Denmark and Greenland, Øster Voldgade 10, 1350 Copenhagen, Denmark. mcit@geus.dk, +45 38142113

Design of the current GEUS AWS started in late 2007, after Campbell Scientific discontinued the CR10X datalogger used in the previous GEUS AWS. In March 2008 the prototype was deployed in NE Greenland as the first unit in the field, and to date it has operated continuously with only routine maintenance for sensor recalibration and normal redrilling of sensors drilled into the ice. As of 2011, all of the ca. 25 AWS operated by GEUS both for research and commercial purposes along the margin of the Greenland ice sheet and on surrounding local glaciers and ice caps share this same design, with a few units carrying project-specific sensor suites and settings. In what follows, the main focus is on the system layout and especially the power supply and satellite telemetry subsystems, as these required specific adaptations to the high latitude environment. The unusual configuration of the multiplexer is also addressed briefly. No details are provided here about the tripod and the mechanical construction, and about the processing chain at the receiving end in Copenhagen, which include decoding, near real-time forwarding of instantaneous observations to the WMO network through the Danish Meteorological Institute (DMI), database assimilation, data calibration, validation, and web serving. The new GEUS AWS met its design goals and complete units or subsystems were delivered to research partners and commercial customers.

## Design goals

The main requirements for the new AWS were: suitability for uninterrupted high latitude operation, reduced need for expensive on-site maintenance, support of a basic suite of sensors comparable to the older GEUS stations, and robust summer and winter satellite data telemetry at all latitudes and topographical settings. The new AWS system is built around the Campbell Scientific CR1000 datalogger and the software, electronics, wiring and mechanical elements are standardized to allow plug-in interchangeability of sensors and parts from any GEUS station, including some from the older design. Extended sensor suites from the basic configuration normally require only adding plugs on the logger box and minor changes to the logger program. Reduced sensor suites require no or minor reconfiguration of the software in the headers of the logger program. Plugs for omitted sensors are usually installed and left empty to ease future additions in the field, an option that has already been used several times.

## GEUS 2008-present AWS design

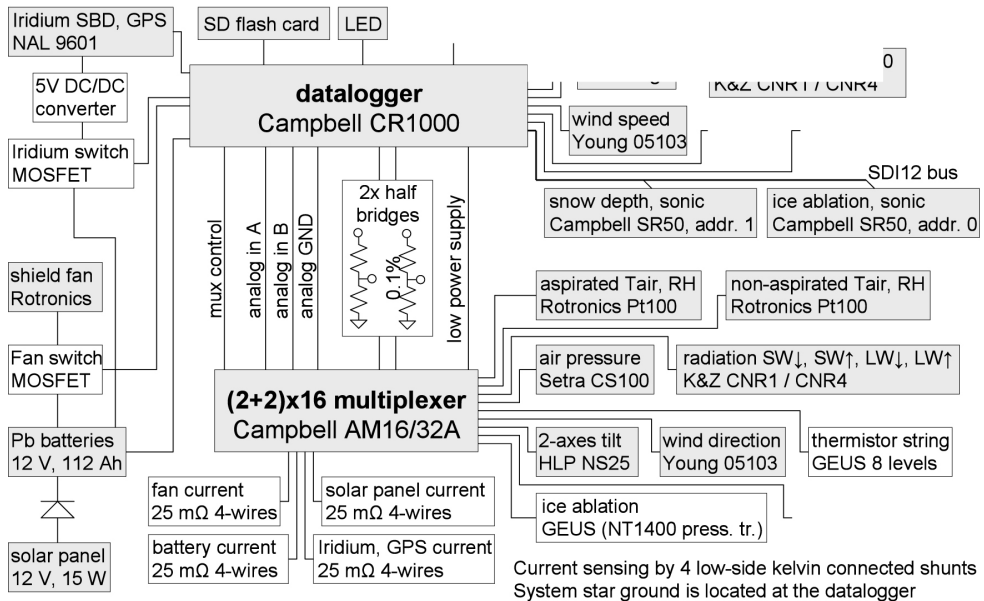

**Figure 1.** Conceptual diagram of the current GEUS AWS for glaciological use in Greenland.

## Sensors suite and multiplexing

The CR1000 measures all analog sensors either directly or through a Campbell AM16/32 multiplexer in a 2+2 x 16 configuration, with two lines going directly to the datalogger and the remaining two being part of two precision half bridges for thermistor excitation and measurement (Fig. 1). Each one of the 16 positions of the multiplexer thus supports two thermistors plus either one differential or two single-ended analog measurements, for a maximum of 32 thermistors plus either 32 single ended or 16 differential measurements in addition to the regular input channels on the CR1000 wiring panel. The basic suite of analog sensors is rather conventional: a Campbell CS100 (Setra mod. 278) barometer, an assembly of a Rotronic forced aspiration radiation shield hosting an MP100H probe with a Pt100 sensor and HygroClip S3 air temperature and relative humidity sensors, a Young 05103 wind monitor, a Kipp & Zonen CNR 1 net radiometer wired so that each one of the four radiometers are measured individually, a custom GEUS 8-levels thermistor string, a custom GEUS ablation meter based on a Ørum & Jensen NT 1400 pressure transducer at the bottom of a fluid column, and an HL-Planar NS-25/E2 two axes tilt meter on the instruments boom to measure the tilt of the CNR 1 radiometers. The digital devices are connected directly to the CR1000 either through the serial RS232 D9 connector (Iridium SBD modem with integrated single frequency GPS) or the datalogger digital channels. To accommodate all devices, the two Campbell Scientific SR50A included in the standard sensors suite share

the same physical channel and are reconfigured to use the addressing capability of the SDI12 bus. A number of additional sensors have been easily added at specific stations, including additional thermistor strings, a second complete Rotronic assembly, a Vaisala HMP45C-L air temperature and RH probe in a passive plate radiation shield, a vibrating wire rain gauge, an experimental snow pillow, a Garmin GPS16X receiver and a Honeywell HMR3300 3-axes solid state compass. For ease of testing the logger program provides a temporary "fast scan" mode repeatedly cycling through the sensors measurement routine and displaying the results.

## **Power**

Power is supplied by four 12V, 28Ah sealed lead-gel batteries wired in parallel in a battery box suspended to the bottom of the tripod mast and acting as a ca. 50 kg ballast. When sunlight is available, the batteries are recharged by a 10W solar panel connected to the battery box via a power Schottky diode on the positive rail and the (optional) current shunt in the logger box on the ground rail. Contrary to the old GEUS stations, the combined 112 Ah nominal battery capacity is not split in "critical" and "secondary" functions. Instead, the logger software manages power consumption according to the programmed settings and to battery voltage, with an automatic low power mode (Tab. 1) where non-essential and power expensive tasks like satellite transmission are automatically suspended. A configurable voltage hysteresis setting ensures stability of transitions between power modes. The CR1000 controls power to most sensors through its built-in 12V output, and two additional power rails with 5A current ratings using two MOSFET switches powering the aspirated radiation screen fan (12V) and the GPS and Iridium SBD modem (5V from a well filtered DC/DC converter). GPS fix and satellite transmission rates can both be set independently for winter and summertime to compromise between power availability, data needs and airtime costs. Up to four system currents are measured through Kelvin-connected shunt resistors: solar panel output, battery output (negative when recharging), aspirator fan current, and satellite modem plus GPS current. This simplifies maintenance in the field, remote diagnostics of faults, and positive check that the aspiration fan was actually running at all programmed times. The common mode range of the CR1000 analog inputs requires low-side sensing of the current shunt. Proper design of the ground system is required to obtain adequate separation of analog and digital grounds and to avoid ground loops especially close to the DC/DC converter and for high impedance signals. The system star ground is electrically located at the CR1000 ground. The cable shields entering the logger box, the internal system ground and the logger box ground lug are electrically tied together and to the metal structure of the tripod. This is meant to provide a controlled and safe electric path to avoid electrostatic discharges through sensitive devices like semiconductors and precision resistors such as the transducers in the wind monitor. It does not provide any lightning protection, as the ice surface the station is standing on is not conductive.

**Table 1.** Conservative example of power budget for a GEUS AWS in the summer, winter and low-power modes of operation. Following field experience, settings have been relaxed toward higher power consumption, with significantly longer aspiration and GPS on times.

<b>Device</b>	<b>average current (mA)</b>	<b>on time (sec/repetition)</b>	<b>daily repetitions</b>	<b>duty cycle (%)</b>	<b>consumption (mAh/day)</b>	<b>consumption (Ah/month)</b>
Aspirator fan	150	45	144	7.50	270	8.21
NAL GPS	120	130	8	1.20	35	1.05
NAL Iridium	150	40	9	0.42	15	0.46
Scan (sensors, MUX, logger)	50	10	144	1.67	20	0.61
System standby	1	1	86400	100.0	24	0.73
<b>WINTER RATES</b>	<b>total monthly consumption (Ah/month)</b>					<b>11.06</b>
<b>Device</b>	<b>average current (mA)</b>	<b>on time (sec/repetition)</b>	<b>daily repetitions</b>	<b>duty cycle (%)</b>	<b>consumption (mAh/day)</b>	<b>consumption (Ah/month)</b>
Aspirator fan	150	45	144	7.50	270	8.21
NAL GPS	120	130	48	7.22	208	6.33
NAL Iridium	150	40	25	1.16	42	1.27
Scan (sensors, MUX, logger)	50	10	144	1.67	20	0.61
System standby	1	1	86400	100.0	24	0.73
<b>SUMMER RATES</b>	<b>total monthly consumption (Ah/month)</b>					<b>17.15</b>
<b>Device</b>	<b>average current (mA)</b>	<b>on time (sec/repetition)</b>	<b>daily repetitions</b>	<b>duty cycle (%)</b>	<b>consumption (mAh/day)</b>	<b>consumption (Ah/month)</b>
Aspirator fan	150	45	0	0.00	0	0.00
NAL GPS	120	130	0	0.00	0	0.00
NAL Iridium	150	40	0	0.00	0	0.00
Scan (sensors, MUX, logger)	50	10	144	1.67	20	0.61
System standby	1	1	86400	100.0	24	0.73
<b>LOW POWER MODE RATES</b>	<b>total monthly consumption (Ah/month)</b>					<b>1.34</b>

## Satellite telemetry and data storage

All GEUS AWS store raw sample records from each measurement locally in a flash card, and most are set to also transmit averaged and/or instantaneous values at a scheduled slower rate of once every one up to three or more hours year-round. Instantaneous observations at synoptic times can be appended, received in near real-time and forwarded to the WMO network through DMI. Current GEUS AWS use modems based on the 9601 and 9602 Iridium SBD transceivers. The polar orbits of the Iridium satellites and their excellent coverage of the poles make this solution vastly superior to the older GEUS stations using the Inmarsat AOR-E and AOR-W geostationary satellites, which are not visible in north Greenland and from most sites on local glaciers and ice caps. The Iridium SBD modem consumes significant power, so it is powered only for short intervals, quickly giving up waiting for service and only retrying once in the (uncommon) circumstance of a failed transmission. To avoid data loss the

CR1000 CRBasic program maintains a message queue of messages that failed to transmit, and it sends them at the first good occasion. The system proved extremely robust, with the first deployed station not having missed a scheduled message over more than 3 years of uninterrupted operation. Diagnostic messages containing a configurable record of additional statistics of battery voltage, system currents, reported transmission failures, length of the waiting message queue, voltage of the lithium memory backup battery and so on are transmitted at longer, weekly to monthly intervals. The logger program has a "force transmission" command to assist in testing and troubleshooting transmission-related problems. Despite Iridium SBD airtime being relatively cheap, a large number of stations sum up to a significant cost. Since 2009 transmissions from most stations have been switched from printable ascii to a custom binary format mimicking the somewhat idiosyncratic 2 bytes base-10 representation of the Campbell Scientific FP2 floating point type and the more standard four bytes signed long integer type. These more compact representations reduced the size of messages by ca. 60% of their ascii equivalents, and the total airtime bill for all stations by several thousands of dollars per year.

# Installing a high-altitude weather station network in the high Argentinean Andes

Sebastián A. Crespo

Instituto Argentino de Nivología, Glaciología y Ciencias Ambientales  
 Casilla de correo 330, Mendoza, Argentina. Tel.: +54-0261-5244033.  
 Email: screspo@mendoza-conicet.gov.ar  
 http://www.glaciares.org.ar

There are many serious gaps regarding the monitoring and understanding of the climate of the Andes in southern South America. Presently there are very few operational high elevation stations along this extensive mountain range, and records covering more than two or three decades are extremely scarce, outdated, and often incomplete. The lack of meteorological information from high elevation sites is a major limitation for studying the past, present and future impacts of climate changes on water resources and glaciers in this region. The Instituto Argentino de Nivología, Glaciología y Ciencias Ambientales (IANIGLA) has initiated a project whose main goals are to install a series of permanent high-altitude weather stations along the Andes and to improve our understanding of the nation's mountain

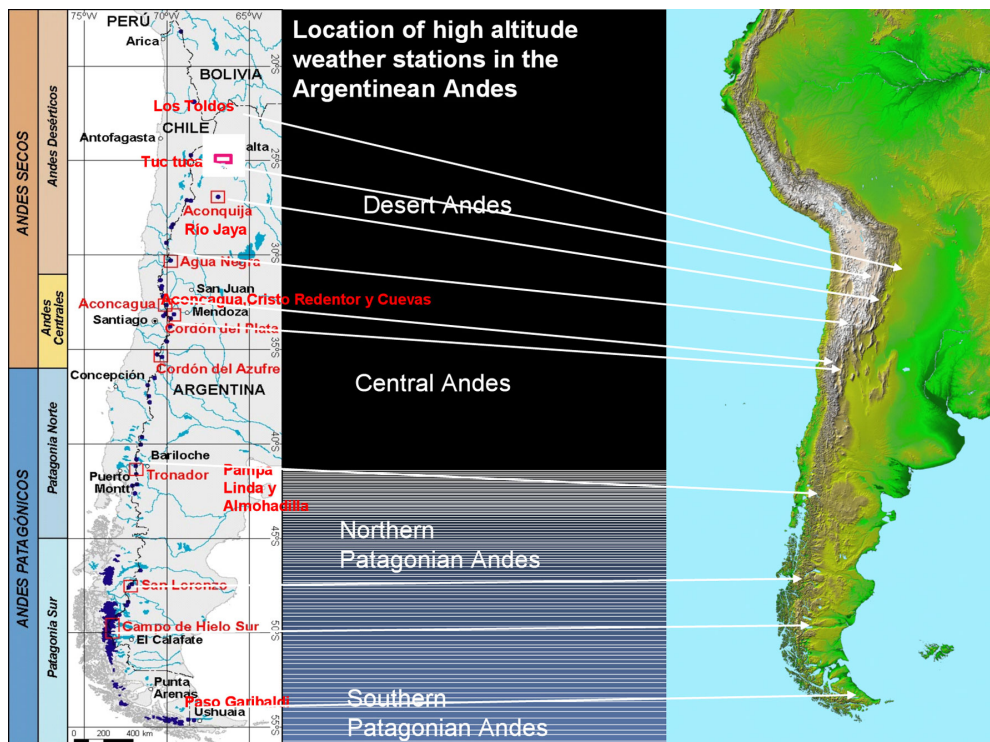

**Figure 1.** Location of the stations that are included in this project.

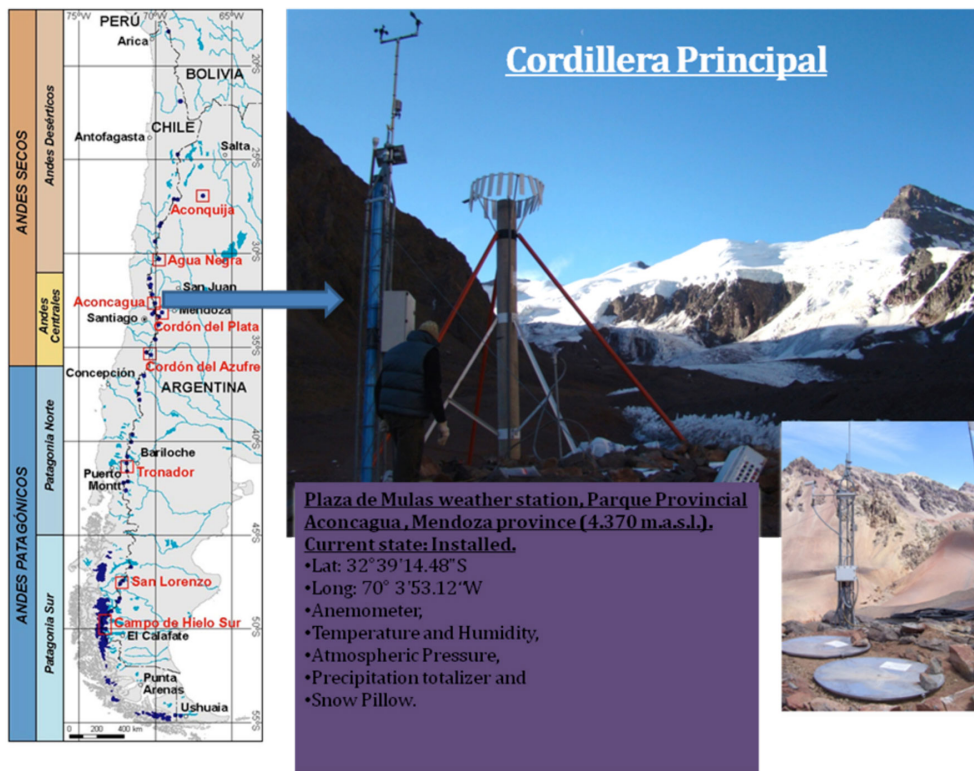

**Figure 2.** Plaza de Mulass weather station near Cerro Aconcagua (6962,m), with Glaciar Horcones Superior and Cerro Cuerno in the background. The station was installed in February 2010. Photos: S. Crespo.

climates for local and regional assessments. The network (Fig. 1) consists of twelve stations from Salta province in the north (22° S) down to Tierra del Fuego province in the southern tip of South America (54° S) that will be monitored and maintained in partnership with the National Undersecretariat of Water Resources. Each station will be equipped with sensors of wind speed and direction, atmospheric pressure, temperature, humidity, and snow and total precipitation.

### Description of sites

- Stations in the Northern portion of the Argentinean Andes (Dry Andes, Figure 1): Three stations: Los Toldos (22.3° S, 64.68° W), Tuctuca (22.4° S, 65.22° W) and Aconquija-Río Jaya (26.83° S, 65.16° W) will be installed in the near future in the Desert Andes. Their elevations range from 1850 to 4200 m and will be crucial for understanding climate variations along this diverse and poorly understood mountainous region. The fourth weather station has already been installed nearby the Aguas Negras International Pass, in the Desert Andes of the San Juan province, at 4500 m (Lat.: 30°11'11.9" S Long.: 69°48'02.5" O).



El Salto hydrometric gauge. Cordillera Frontal,  
Central Andes.

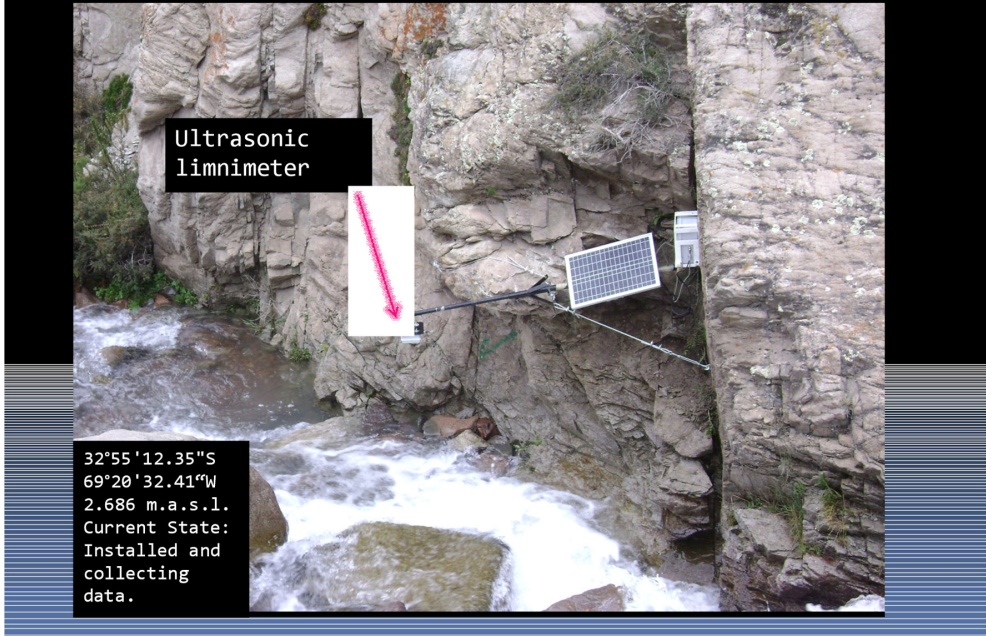

**Figure 3.** The ultrasonic water level sensor developed recently by S. Crespo to monitor the creek discharges with turbulent flux. The station was installed on February 2011 and is currently measuring the hourly streamflow incoming from the rock glacier El Salto.

- Stations in the Central Andes (Fig. 1): In this portion of the Argentinean Andes there are two main mountain ranges with different climate regimes: Cordillera Principal and Cordillera Frontal. In the Cordillera Principal we recently installed the "Plaza de Mulass" weather station (Fig. 2) at 4370 m of elevation in the Aconcagua mount Provincial Park, and a few km to the south of Cerro Aconcagua, the "Las Cuevas" and "Cristo Redentor" weather stations (32°48' S, 70°03' W, 3200 m and 32° 49' S, 70°04' W, 3850 m, respectively) have already been in the area. In the Cordillera Frontal the "Vallecitos" weather station is also already installed together with a hydrometric gauge in front of the "El Salto Rock Glacier" (Fig. 3).
- Stations in the North Patagonian Andes (Fig. 1): There will be two stations installed in northern Patagonia, the "Pampa Linda" (41°12' S, 71° 48' W, 850 m) and "La Almohadilla" (41°11' S, 71°48' W, 1400 m), both nearby "Monte Tronador" (3478 m) in the Río Negro province.
- Stations in the South Patagonian Andes (Fig. 1): Four stations will be installed in this region. The "Perito Moreno" weather station in the Perito Moreno National Park, nearby Nansen Lake (47°48' S, 72°13' W, 970 m).; the "Chaltén" weather station in the Chaltén village (49°.20' S, 72°.50' W, 394 m), and another station located on the eastern margin

of the South Patagonian Icefield near Glaciar Túnel (49°23' S, 73°04' W, 815 m). Further south, in the Tierra del Fuego province, another weather station will be installed at "Paso Garibaldi" (54°.40' S, 67°.50' W, 285 m).

### **Acknowledgements**

I would like to thank to Dr. Mariano Masiokas and Dr. Ricardo Villalba for their guidance in my studies, Dr. Brian Luckman (University of Western Ontario, Canada) and the Inter-American Institute for Global Change Research (through the project CRN 2047) for the support to attend this meeting, and the organizers and all the people I met in the workshop during that wonderful week in Pontresina.

# AWS measurements on glaciers in the Italian Alps

G. Diolaiuti<sup>1</sup>, A. Senese<sup>1</sup>, C. Mihalcea<sup>1</sup>, G.P. Verza<sup>2</sup>, B. Mosconi<sup>1</sup> and C. Smiraglia<sup>1</sup>

<sup>1</sup> Earth Sciences Department of Milan University (Italy).

Email: guglielmina.diolaiuti@unimi.it, antonella.senese@unimi.it, claudia.mihalcea@unimi.it

<sup>2</sup> Evk2CNR Committee Bergamo (Italy).

## Introduction

A network of automatic weather stations (AWS) located at high altitude on the most representative Italian glaciers was developed by researchers of Earth Sciences Department (ESD) of University of Milan (UNIMI) starting from 2005. The first AWS was installed in the ablation area of Forni Glacier, (Upper Valtellina, Lombardy) on 26<sup>th</sup> September 2005, followed by installation in 2007 of three other AWSs: on East Dosdè Glacier (Upper Valtellina, Lombardy), Venerocolo Glacier (Adamello Group, Lombardy) and Gèant Glacier (Mont Blanc Group, Valle d'Aosta). The AWS set up on Forni Glacier is similar to the Morteratsch glacier AWS managed by University of Utrecht. Also the other AWSs used this set up as a model, since it is considered as one of the best for melting surfaces in the ablation area of alpine glaciers.

High altitude meteorological conditions over glaciers of Western and Central Italian Alps and consequences for energy and mass balance of glaciers are analysed from collected data. In particular, the glacier surface energy fluxes are analysed and the surface energy balance and total melting are calculated. Snow accumulation was also measured to estimate the glacier mass balance. The datasets from the 4 AWSs are compared with data from synoptic stations situated outside the glaciers and with other supra-glacial AWSs (e.g. AWS on Morteratsch glacier). The analysis and comparisons are made in collaboration with Department of Physics of UNIMI (Prof. Maugeri), ARPA Lombardia, ARPA Valle d'Aosta and Valle d'Aosta Region.

## The AWSs

The specifications of the sensors at each station are presented in Tables 1 and 2 (Fig. 1).

The **AWS1 Forni** (Fig. 1a) is set up on the ablation tongue at the base of the Eastern icefall of Forni Glacier. The AWS was checked several times, particularly during the first year, and no important issues were observed (Citterio *et al.*, 2007; Senese *et al.*, 2010, 2011). Despite the high winter snow accumulation, the AWS is never completely covered by the snow (Fig. 1a at the end of March 2010). This data record is the longest from

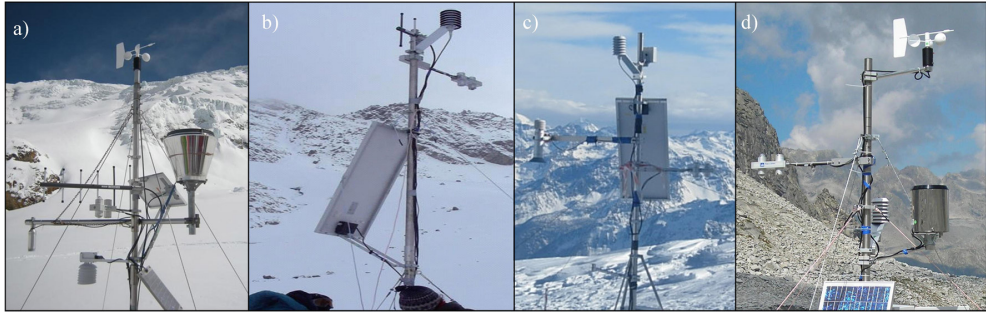

**Figure 1.** The four AWSs. From the left: AWS1 Forni (a), AWS Dossdè-Levissima (b), AWS Monte Bianco-Osram (c) and AWS Venerocolo (d).

**Table 1.** Structure details of AWSs.

	<b>AWS1 Forni</b>	<b>AWS Dossdè-Levissima</b>	<b>AWS Monte Bianco-Osram</b>	<b>AWS Venerocolo</b>
<b>Data Logger</b>	LSI-Lastem Babuc ABC	LSI-Lastem e-log	LSI-Lastem e-log	LSI-Lastem e-log
<b>GSM Modem</b>	YES	YES	YES	NO
<b>Steel mast</b>	5 m	5 m	5 m	5 m
<b>Battery</b>	100 Ah	100 Ah	100 Ah	100 Ah
<b>Panel solar</b>	40 W	40 W	40 W	40 W
<b>Memory card</b>	2 Mb (6 months)	2 Mb	2 Mb	2 Mb

an Italian AWS. Only a break in the data set is observed from 5<sup>th</sup> to 11<sup>th</sup> October 2008.

The **AWS Dossdè-Levissima** (Fig. 1b) was installed in summer 2007 on the ablation area of Dossdè Glacier (Cima Piazzzi Group). It's the highest permanent station in Lombardy Region (2850 m a.s.l.). The data were used to analyse the energy exchanges during the first Italian experiment of "glacial protector", on Dossdè Glacier (Diolaiuti *et al.*, 2009). In addition an hydrological station was installed to measure meltwater discharge of Viola Torrent in collaboration to Politecnico of Milan (POLIMI). Then the hydrological balance of the whole glacierized basin can be calculated from these data.

The **AWS Monte Bianco-Osram** (Fig. 1c), installed in collaboration with the EVK2CNR, is the highest Italian permanent AWS on glacier (at about 3430 m a.s.l.). The station is located about 400 m from the "Punta Helbronner" station of Mont Blanc cable car, in the Gèant Glacier accumulation area. It is easily accessible, not too visited by tourists and excursionists, external to the snow cat working area (near the Punta Helbronner the snow is removed to fill up crevasses). To measure continuously rock temperature at these elevations with different exposition, an automatic station was set up in 2008 close to the AWS in collaboration with the researchers of Insubria University (BST). The aim is to measure the thermal cycles in the rock walls at different depths and intensity of periglacial process and permafrost degradation in alpine high altitude areas. The AWS

**Table 2.** Structure details of AWSs.

Variable	Range	Accuracy	Manufacturer	Forni	Dosdè	Bianco-Osram	Venerocolo
<b>Air Temperature</b>	-30-+70°C	±0.001°C	LSI-Lastem DMA570	30 min.	30 min.	30 min.	10 min.
<b>Relative Humidity</b>	0-100 %	±1%	LSI-Lastem DMA570	30 min.	NO	30 min.	NO
<b>Air Pressure</b>	400-800 hPa	±10 hPa	LSI-Lastem DQA223	60 min.	30 min.	30 min.	10 min.
<b>Solar Radiation</b>	0.3-3 μm	±5%	Kipp and Zonen CNR-1	30 min.	30 min.	30 min.	10 min.
<b>Infrared Radiation</b>	5-50 μm	±5%	Kipp and Zonen CNR-1	30 min.	30 min.	30 min.	10 min.
<b>Snow level</b>	0-1000 cm	±2 cm	Campbell SR50	60 min.	**	60 min.	NO
<b>Rain</b>	0-1000 mm	±1 mm	LSI-Lastem DQA035	30 min.	NO	NO	60 min.
<b>Wind Speed</b>	0-50 ms <sup>-1</sup>	±1%	LSI-Lastem DNA022	60 min.	NO	NO	10 min.
<b>Wind Direction</b>	0°-360°	±1°	LSI-Lastem DNA022	60 min.	NO	NO	10 min.

\*\* Only during first winter

data (in particular mass gains) complete the monitoring of ablation areas of Mount Blank Massif.

The **AWS Venerocolo** (Fig. 1d) (2621 m.a.s.l.) is located on the median moraine, of the debris-covered ablation area. It was installed on July 27<sup>th</sup> 2007 and removed on October 11<sup>th</sup> 2007. To complete the analysis, thermistors were installed into the debris to measure the conductive heat flux through debris layer. Energy fluxes at the air-debris-ice interface were analyzed to calculate the energy available for ice melting and the debris cover influence.

## Controls

The battery level is recorded by the data logger to allow a test during the data downloading. The battery-only power supply, is estimated in excess of two months, with the solar panels permanently obscured by snow accumulation and accounting for low temperature operation and self discharge.

The download is every day thanks to the GSM modem. The connection allows a test of the instruments and so the maintenance by the researchers (e.g. the damage of solar panel and so the decreasing of battery power).

## Difficulties

Regarding AWS1 Forni and AWS Dosdè-Levissima, the most difficulty is to get to the AWS during winter, it's possible only by downhill ski (with a

limited possibility to carry the equipment) or by helicopter (less limits but more costs).

The limit of all AWSs is the energy autonomy, in fact the solar panels are enough to power for the station, but another panel was necessary to the GSM modem. Thus to implement the instruments (e.g. additional ventilated thermometer) is necessary to provide to auxiliary energy systems.

At the installation the pluviometer of AWS1 Forni was at the surface, but in 2007 it was replaced at the height of other sensors due to the disturb by frequent visits by the tourists and excursionists.

Because the AWS Monte Bianco-Osram is on the accumulation zone, during winter it's completely covered by the snow. This causes the stop of the battery loading by solar panel, consequently it was often necessary to replace the battery.

The debris-covered surface makes it difficult to maintain the AWS Venerocolo for more than one season, so it was removed on October.

## **Comparisons**

Regarding air temperature records, the comparisons made by researchers of Physic Institute (UNIMI) show a best agreement between the datasets with a slight overestimation during spring season due to the naturally ventilated thermometer. The choice of this type of sensor is due to the energy consume. To estimate the overestimation amount, a ventilated sensor with secondary supply will be installed to analyze the differences between the data from two sensors. Regarding measured energy fluxes, these results are in agreement with data from Morteratsch Glacier ([Oerlemans, 2001](#)).

The AWS sites are routinely monitored by surveyors from Regional Agency for Environmental Protection (ARPA Lombardia and ARPA Valle d'Aosta), thus making it possible to compare the snow pit data collected by these surveyors with the data recorded from the sonic ranger of stations. Comparison of the two datasets confirms the reliability of the data acquired by the sonic ranger.

## **Future projects**

We would like to install other meteorological stations: 1) in accumulation basin of Forni Glacier to evaluate the mass gains and albedo, 2) outside the Dosedè Glacier (in a lower part) to determinate the local gradients and measure the liquid precipitation nearby the hydrological station and 3) in ablation zone of Giant Glacier to evaluate the mass loses.

Another next step of our research will be the installation of two automatic hydrologic stations at Forni and Giant Glaciers sites to quantify the flows and so the hydrologic balance of glacierized basin.

With a view to the improvement of AWS Dosedè-Levissima and AWS Monte Bianco-Osram, the addition of other sensors to measure of wind

direction and speed and liquid precipitation (that increases the melting during summer periods) should be considered.

## References

- Citterio, M., G. Diolaiuti, C. Smiraglia, G. Verza and E. Meraldi. 2007. Initial results from the automatic weather station (aws) on the ablation tongue of forni glacier (upper valtellina, italy). *Geografia Fisica e Dinamica Quaternaria*, **30**, 141–151.
- Diolaiuti, G., C. Smiraglia and E. Meraldi. 2009. Strategie di protezione “attiva” dei ghiacciai. neve e valanghe.
- Oerlemans, J.. 2001. *Glaciers and Climate Change*. Balkema. pp. 148.
- Senese, A., D. Diolaiuti, C. Mihalcea and C. Smiraglia. 2010. Evoluzione meteorologica sulla lingua di ablazione del ghiacciaio dei forni, gruppo ortles-cevedale (parco nazionale dello stelvio, lombardia) nel periodo 2006-2008. *Bollettino Della Società Geografica Italiana*, *XIII*, **3**(4), 845–864.
- Senese, A., D. Diolaiuti, C. Mihalcea and C. Smiraglia. 2011. Energy and mass balance of forni glacier (stelvio national park, italian alps) from a 4-year meteorological data record. *Arctic, Antarctic, and Alpine Research*. Accepted.

# WMO's Global Cryosphere Watch (GCW) and incorporation of *in-situ* Glacier Observations

Dr. Barry Goodison

Observing and Information Systems Department World Meteorological Organization (WMO), Geneva, Switzerland

## Introduction

The cryosphere, its changes, and its impacts, have received increased scientific scrutiny in recent years, and now receive continual attention by decision makers and coverage by the media, creating an unparalleled demand for authoritative information on past, present and future states of the world's snow and ice resources. The cryosphere is global, existing in various forms spanning all latitudes and occurring in approximately one hundred countries in addition to the Antarctic continent. Yet, it remains the most under-sampled domain in the climate system.

WMO, with the co-operation of other national and international bodies, organizations and institutes and using its global observing and telecommunication capability, is in a position to provide an integrated, authoritative, continuing assessment of the cryosphere - a Global Cryosphere Watch (GCW). At its Sixteenth World Meteorological Congress (Cg-XVI), WMO approved the GCW Implementation Strategy ([Link](#)) (as part of its decisions on Polar activities document) which outlines the next steps for developing GCW. WMO's Executive Council Panel of Experts on Polar Observations, Research and Services (EC-PORS) will guide development of GCW (see [Link](#)). Support for GCW was expressed by representatives of countries from all of WMO's six Regions, with many developing countries specifically identifying the important impacts that glacier change is having on their country.

## Global Cryosphere Watch

GCW, in its full/comprehensive form, would include observation, monitoring, product development, assessment, prediction, and related research. It would provide the international mechanism for implementing the recommendations of the report of the Integrated Global Observing Strategy (IGOS) Cryosphere Theme (CryOS) ([IGOS Cryospheric Theme, 2007](#)) which identified observational requirements and gaps for cryospheric observing and monitoring, including those for glaciers. CryOS development engaged over 80 scientists from Europe, North America and Asia and has become the key document on cryospheric observational needs from both satellite and in-situ observing systems. GCW aims to ensure a comprehensive, coordinated, and sustainable system of in-situ and satellite observations and information and access to related information through the WMO Integrated



Observing System ([WIGOS](#)) and the WMO Information System ([WIS](#)) to allow full understanding of the cryosphere, its changes and its interactions within the earth system.

GCW would include all elements of the cryosphere at national, regional and global scales and would build on and integrate what is being done already by WMO Members and other operational and research organizations institutes and international programs. Collaboration, partnership and engagement of various programs is essential in providing reliable, comprehensive observations of the components of the cryosphere through an integrated observing approach from national to global scale to meet the needs of climate, hydrology, weather and environmental science on a multitude of time and space scales, reaching from polar ice to tropical glaciers. WMO specifically requested that GCW engage pilot and demonstration projects in different regions of the world, including tropical regions with glaciers.

### **Contribution of Automatic Measuring Systems on Glaciers to GCW**

Achieving sustained observation and monitoring of the cryosphere and related environmental variables is a key task in the development of GCW. Reference sites will be a key element in the effort to establish or consolidate best practices, guidelines and standards for cryospheric measurement (including metadata standards) in co-operation with responsible bodies within WMO and with partner scientific associations and inter-governmental bodies. This will include consideration of data homogeneity, interoperability, and compatibility of observations from all GCW constituent observing and monitoring systems and derived cryospheric products. A prototype GCW portal is currently under development to facilitate the exchange of, and access to, cryospheric data, information and products.

Automatic measuring systems are recognized as essential and have a special role in acquiring observations in remote, often hostile environments, including the world's ice sheets and mountain glaciers. For example, the Greenland Climate Network (GC-Net), initiated in 1990 with the intention to monitor climatological and glaciological parameters at various locations on the Greenland Ice Sheet over several decades to study the climate variability, now has 20 automatic stations in operation that report in near-real time - a sustained observing network. Likewise in the Antarctic, automatic weather stations often operated by research institutes provide the spatial distribution of measurement so essential in understanding variability and change. These will be part of the new WMO Antarctic Observing Network (AntON). There are numerous examples of automatic stations on or near glaciers in the world's mountain regions, providing data for a variety of purposes, but not necessarily being part of an integrated observing network providing real and near real-time observations.

GCW will initiate a comprehensive cryosphere observing network called "CryoNet", a network of reference sites or "supersites" in cold climate re-

gions, on land or sea, operating a sustained, standardized programme for observing and monitoring as many cryospheric components as possible. Initially, it will build on existing cryosphere observing programmes or add standardized cryospheric observations to existing facilities to create supersite environmental observatories. GCW will facilitate the establishment of high-latitude and high-altitude supersites with co-located measurements of as many key cryospheric and related environmental variables as possible. Wherever possible, these would also serve as long-term cryospheric calibration / validation sites for satellite derived cryospheric products and model outputs.

Existing cold climate observatories, such as those in the WMO Global Atmosphere Watch (GAW), are potential sites for establishing or enhancing cryospheric observations. The Finnish Sodankylä-Pallas supersite in the boreal forest of northern Finland has been offered as a CryoNet site. Its infrastructure is already designed for integrated monitoring of soil-snow-vegetation-atmosphere interaction and provides reference measurements for satellite sensors on a continuous basis. Likewise the GCOS/GTOS Networks for Permafrost (GTN-P), Glaciers (-G) and Hydrology (-H) may offer potential reference sites while providing key observations from their global networks. The World Glacier Monitoring Service (WGMS), for example, has stated that it is willing to support GCW with data, information and expertise from within the Global Terrestrial Network for Glaciers (GTN-G).

WMO Member countries, through their cryosphere focal points, are being asked to recommend suitable sites. China, for example, is establishing supersites in the "Third Pole" region where the High Asian Cryosphere (HAC) serves as the Asian "water tower" for over a billion people (Xiao Cunde, Chinese Meteorological Administration; pers. comm.). Several Chinese institutes, including the State Key Laboratory of Cryospheric Sciences, are planning seven supersites with each containing several reference sites for the HAC. The long-term purpose is to benefit the operational level of regional/global weather/climate prediction, as well as a better water-usage assessment. The supersites are designed to cover major geographic units and climatic zones of the region, thus representing most cryospheric components and types. Measurements include many different variables of cryospheric components (glacier, snow cover, frozen ground/permafrost, lake/river ice, solid precipitation, hydrology), and other components related to the climate system (atmosphere, biosphere) using automatic, manual, and satellite methods. They have offered to merge the HAC sites into CryoNet and help lead the development of standardized cryosphere observing programmes. Inclusion of other sites in the region would be especially useful for long-term, integrated monitoring.

GCW will work to engage operators of observing systems in mountainous regions, working collaboratively with institutes, agencies and programs. GCW will initiate efforts to engage additional agencies to enhance observing in high altitude/glacier zones in all regions of the world, including the implementation of high altitude reference sites. In some countries,

meteorological services operate glacier observing networks, while in others it may be a different agency or academic institute. GCW recognizes that automatic observing of cryospheric components and related environmental variables on and near glaciers will be critical to improve our collective understanding of cryospheric change in mountainous regions of the world.

## **References**

GCW development. <http://www.wmo.int/pages/prog/www/Antarctica/antarctic.html>.

GCW implementation strategy. [ftp://ftp.wmo.int/Documents/SESSIONS/Cg-XVI/English/Approved%26Corrected/PINK11-9\\_POLAR\\_ACTIVITIES\\_en\\_2.doc](ftp://ftp.wmo.int/Documents/SESSIONS/Cg-XVI/English/Approved%26Corrected/PINK11-9_POLAR_ACTIVITIES_en_2.doc).

IGOS Cryospheric Theme. 2007. A cryosphere theme report for the igos partnership. WMO/TD-No. 1405, World Meteorological Organisation (WMO), IGOS Integrated Global Observing Strategy. [http://igos-cryosphere.org/docs/cryos\\_theme\\_report.pdf](http://igos-cryosphere.org/docs/cryos_theme_report.pdf).

WMO integrated observing system (WIGOS). [http://www.wmo.int/pages/prog/www/wigos/index\\_en.html](http://www.wmo.int/pages/prog/www/wigos/index_en.html).

WMO information system (WIS). <http://www.wmo.int/pages/prog/www/WIS/>.

# **AWS measurements at the Belgian Antarctic station Princess Elisabeth, in Dronning Maud Land, for precipitation and surface mass balance studies**

Irina V. Gorodetskaya<sup>1</sup>, Nicole P.M. van Lipzig<sup>1</sup>, Wim Boot<sup>2</sup>, Carleen Reijmer<sup>2</sup>, Michiel R. van den Broeke<sup>2</sup>

<sup>1</sup> Department Earth and Environmental Sciences, Katholieke Universiteit Leuven  
Celestijnenlaan 200E, Heverlee, 3001, Belgium  
Email: Irina.Gorodetskaya@ees.kuleuven.be

<sup>2</sup> Institute for Marine and Atmospheric Research, Utrecht University, Netherlands

## **Introduction**

The Antarctic mass balance and the hydrological cycle of the entire planet are tightly linked together. Evaporation from the ocean surface in the tropical and middle latitudes, poleward moisture and energy transport, changes in the midlatitude atmospheric dynamics, cloud formation microphysics - all these processes determine the amount of precipitation in Antarctica. The main objective of our project is to improve the understanding of the atmospheric branch of the hydrological cycle of Antarctica covering the chain from evaporation/sublimation at the surface via cloud formation to snowfall. As there is a lack of data on the clouds and precipitation processes in the Antarctic, the first goal is to establish a new database that can be used for local process studies and large-scale model evaluation. The base for our measurements is the new Belgian Antarctic station Princess Elisabeth (PE) built on the Utsteinen Ridge in Dronning Maud Land, East Antarctica (71°57'S and 23°20'E, ~1400 masl, 180 km inland). Princess Elisabeth station is located in a nearly thousand kilometer wide "data gap", where no long-term measurements of the surface mass balance have been done up to date and where regional climate models show large differences in snow accumulation estimates.

## **Measurements**

The meteorological data have been collected by an Automatic Weather Station (AWS) installed 300 m east from the Utsteinen ridge in February 2009 (Fig. 1, Tab. 1). The AWS provides hourly mean data of near-surface air temperature, relative humidity, pressure, wind speed and direction, up and downward directed broadband short-wave and long-wave radiative fluxes, snow height changes, and a 1 m snow temperature profile. In addition, ground-based cloud and precipitation remote-sensing instruments have been operating during several months, from which characteristics of cloud properties and individual storms have been derived. Information

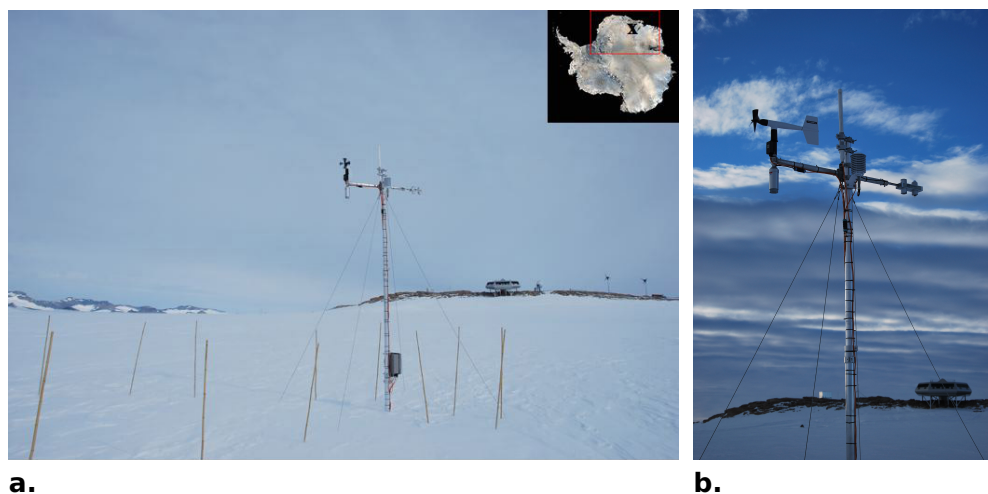

**Figure 1.** Automatic Weather Station installed as part of the HYDRANT project near the Belgian Antarctic station Princess Elisabeth. The AWS is designed by the IMAU group ([Link](#)). (a) Photo of the AWS in February 2010; (b) zoom on the instrument yard.

about the instruments and measurement campaigns can be found on the project website ([Link](#)).

### Method of filtering the snow height data

Measurements of snow height changes using ultrasonic altimeter sensor provide hourly data with 0.01 m accuracy (Tab. 1). The measurements are highly sensitive to the air temperature and correction is applied using the AWS near-surface air temperature measurements assuming isothermal temperature profile. In addition, prior to computing daily accumulation

**Table 1.** Configuration of the AWS installed as part of the HYDRANT project at the Belgian Antarctic Princess Elisabeth base.

Variable	Sensor	Range	Accuracy
Temperature	Vaisala HMP35AC	-80 to +56 °C	0.3 °C
Relative Humidity (with respect to liquid)	Vaisala HMP35AC	0 to 100%	2% (RH<90%) 3% (RH>90%)
Wind Speed	Young 05103 propvane	0 to 60 m/s	0.3 m/s
Wind Direction	Young 05103	0 to 360°	3°
Pressure	Vaisala PTB101B	600 to 1060 hPa	4 hPa
Shortwave radiation	Kipp CNR1	305 to 2800 nm, 0 to 2000 W/m <sup>2</sup>	2%
Longwave radiation	Kipp CNR1	5 to 50 μm, -250 to +250 W/m <sup>2</sup>	15 W/m <sup>2</sup>
Height above snow	SR50	0.5 to 10 m	0.01 m or 0.4%
Power supply	SL-790 Lithium batteries		
Data transmission	ARGOS		

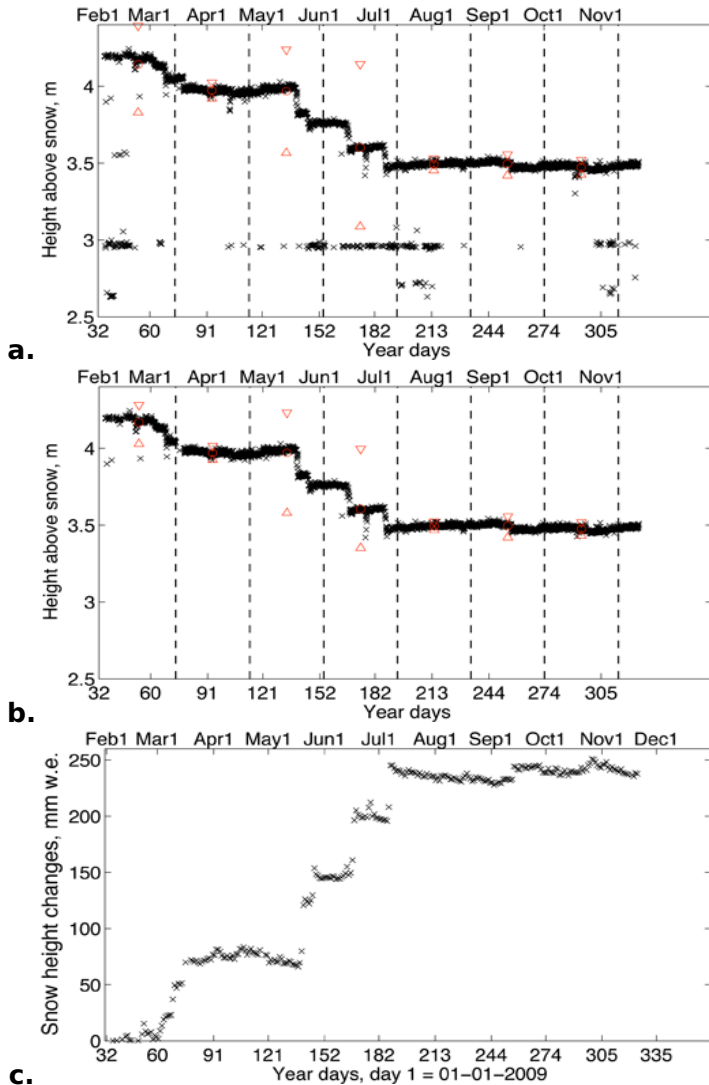

**Figure 2.** Filtering method for the height above snow measurements during 2009: (a) original 2-hourly data with red triangles showing the upper and lower demarcation lines for the outliers based on the inter-quartile range; (b) 2-hourly data with the outliers rejected after the first filter with the new demarcation lines; (c) daily accumulation data calculated based on the filtered 2-hour snow height values, converted to mm w.e. (water equivalent) using local measured snow density (Tab. 2).

values, the original hourly measurements of height above the snow surface were subject to filtering to eliminate false reflections. During snowfall there are possible reflections from individual snowflakes. There are also some parts of the AWS mast, which can be giving false signals. This problem was discussed intensively during the workshop and apparently is a challenge for many AWS observations on glaciers and ice sheets. After trying out various techniques, we found a reliable statistical method of

**Table 2.** Annual mean values of major meteorological variables measured by the AWS at Utsteinen (standard deviations and extreme values are based on daily means).

Variable	2009		2010	
	Mean±std	Min/Max	Mean±std	Min/Max
Air temperature (K)	254.0 ± 5.4	240 (Aug) / 267 (Feb)	253.7 ± 7.1 *	237 (Jul) / 269 (Jan)
RH (%) with respect to ice	61 ± 22	18 / 102	48 ± 19 *	16 / 101
Specific humidity (g/kg)	0.58 ± 0.37	0.1 / 2.1	0.52 ± 0.51 *	0 ** / 2.6
Pressure (hPa)	827 ± 8.7	802 / 857	842 ± 10.3	802 / 850
Wind speed (m/s)	5.3 ± 3.4	0.1 / 17.3	4.6 ± 2.6	1.3 / 17.5
Total accumulation (mm w,e.) ***	235		26	

\* A gap exists in air temperature and humidity data from Oct 17 to Dec 22 2010.

\*\* Specific humidity less than 0.1 g/kg is below the measurement accuracy of Vaisala humicap (Table 1).

\*\*\* accumulation calculated from snow height difference between the first and the last day of each year using the snow density = 335.7 kg/m<sup>3</sup> measured Feb 2009 near the AWS.

data filtering taking into account variability during quasi-monthly period (40 day) for the year with large step-wise accumulation events, and yearly variability (yearly mean  $\pm 3\sigma$ ) for the year with nearly zero total accumulation. As the accumulation can vary quite drastically over time and space, a filtering method can differ for various locations and even for different years at one location depending on the accumulation variability patterns, amounts and the height of the snow sensor above the snow. Thus, special scrutiny is required for accumulation data based on the knowledge of local processes.

For the year 2009 with large step-wise accumulation events, the quartile filter was applied to the height above snow data (Fig. 2). The original 2-hour time series was divided into 40-day intervals, and quartiles were calculated for each interval. The demarcation line for the outliers was calculated as  $Q3 + 1.5 \cdot IQR$  for the top and  $Q1 - 1.5 \cdot IQR$  for the bottom whisker, where  $Q3$  is the upper quartile,  $Q1$  is the lower quartile, and  $IQR$  is the inter-quartile range (Tukey, 1977). For 2010, the inter-quartile range was found to be very small, restricting the snow height change variability beyond physically possible values. Thus, the  $3\sigma$  filter was applied to the 2010 hourly values. Daily mean snow height change values were calculated from the filtered hour data. Daily accumulation was computed as the difference between snow height values of the two consecutive days. In the final verification of the filtered data set, the daily accumulation data were checked for closure, i.e. difference between the total sum of all positive and all negative daily accumulation values should be nearly equal to the difference between the first and the last daily mean snow height for each year.

## Some meteorology and accumulation characteristics

The AWS measurements during 2009-2010 showed that the Utsteinen site is characterized by relatively mild meteorological conditions (Tab. 2). The minimum daily mean near-surface air temperature observed during 2009-2010 was 237 K and the maximum daily wind speed was 17 m/s (maximum hourly wind speed of 30 m/s was recorded during 2009 winter). The AWS is located north of Sør Rondane mountains, east of the Utsteinen ridge, in a valley, at the tongue of the outlet glacier Gunnestadbreen. This glacier is believed to channel the katabatic wind at PE (Pattyn *et al.*, 2010). Indeed, a small percentage of high wind speeds at Utsteinen was associated with cold temperatures indicating enhanced katabatic wind. Despite these rare channeling events, the large scale katabatic flow, typically limited to 500-1000 m above the surface in the Antarctic escarpment zone (Parish and Bromwich, 2007), is blocked by the mountain range reducing the katabatic wind speeds in the AWS locality. Wind speeds stronger than 5 m/s are restricted to the E-SE direction and are mostly associated with cyclonic activity in the near-coastal ocean region. Cluster analysis has shown that the warm periods with strong wind speeds are associated with increased cloudiness and accumulation, while cold periods have calm wind speeds and either zero accumulation or slight net ablation (by sublimation or wind erosion). Few strong accumulation events were responsible for the majority of the total yearly accumulation during 2009 (Fig. 2c). The ongoing research using the AWS data includes analysis of synoptic controls of precipitation, and estimates of sublimation rates at Utsteinen compared to other Dronning Maud Land stations.

## References

- Hydrant project website. <http://ees.kuleuven.be/hydrant>.
- IMAU aws site. <http://www.projects.science.uu.nl/iceclimate/aws/>.
- Parish, T. and D. Bromwich. 2007. Reexamination of the near-surface airflow over the antarctic continent and implications on atmospheric circulations at high southern latitudes. *Mon. Weather Rev.*, **135**, 1961-1973.
- Pattyn, F., K. Matsuoka and J. Berte. 2010. Glacio-meteorological conditions in the vicinity of the belgian princess elisabeth station, antarctica. *Antarctic Science*, **22**(1), 79-85.
- Tukey, J.. 1977. *Exploratory Data Analysis*. Addison-Wesley, Reading, MA. 688 p.



# High-elevation weather stations on glaciers in the Tropics - 2011 update

Douglas R. Hardy

Climate System Research Center and Geosciences Department, Univ. Massachusetts, Amherst

Climate measurements continue at automated weather stations (AWS) on Quelccaya Ice Cap, Perú and on Kilimanjaro's Northern Ice Field (Tanzania). Situated on flat surfaces at the glacier's highest elevations (5680 m and 5775 m, resp.), these locations were selected to represent what are now - or once were - tropical glacier accumulation zones. The AWS began operating in August 2003 and February 2000, respectively, to provide a better understanding of processes by which ice cores record climate (e.g. [Hardy et al., 2003](#)); long ice-core records have been developed from both sites ([Thompson et al., 1985, 2002](#)), and limited mass balance studies are on-going.



**Figure 1.** AWS on Quelccaya (left) and Kilimanjaro (right; stations are adjacent to one another). The Quelccaya tower and one of those on Kilimanjaro are custom, modular designs of aluminum tubing and structural fittings. Recently, radiation shields compatible with the U.S. Climate Reference Network (USCRN) began operating at both sites, visible in images as large white disks with vertical tubes beneath; these house 3 PRTs each to measure temperature and a Vaisala HMT337 for humidity measurement.

AWS instrumentation is similar at the two sites, as shown in Figure 1 and detailed elsewhere (Thompson *et al.*, 2002; Link). However, the tower designs differ considerably, due to contrasting mass balance regimes in recent years. For example, the average net mass balance (w.e.) for 2005-2010 at Quelccaya AWS was  $\sim +0.8$  m, in contrast to  $\sim -0.24$  m over the same time interval at Kilimanjaro AWS. Consequently, to maintain a relative constancy of measurement heights, we lowered the entire Kilimanjaro tower 4 times due ablation, and have extended the Quelccaya station by 12 m due accumulation. This experience underscores the reality that AWS tower design must be adapted to the mass balance regime in which it is located. An initial evaluation of each station's performance was provided at the 2004 AWS Workshop in Pontresina (Hardy *et al.*, 2004).

The Quelccaya and Kilimanjaro sites are at similar elevations, yet measurements reveal important differences in climate. The magnitude of precipitation at Quelccaya, for example, is 4-6 times greater and delivered during one wet season. A more-variable, bimodal precipitation pattern predominates on Kilimanjaro. Also, the Quelccaya site is warmer, with aspirated air temperature typically rising above freezing on more than 100 days per year; Kilimanjaro air temperature remains below freezing. An extended dry season occurs at both sites, during which the mean relative humidity averages 63 and 44 percent, respectively. As a result of these differing climates, the resolution and fidelity of environmental history records from the ice cores also differs considerably (cf., Thompson *et al.*, 1985, 2006, 2002; Kaser *et al.*, 2010).

### **Issues, challenges, and lessons learned**

An abundance of challenges are inherent in all unattended measurements on glaciers, as discussed by Box *et al.* (2004). These include adapting to a surface height which is often changing constantly, meeting power requirements despite riming and snowfall, keeping the tower plumb, and for researchers, simply functioning at high elevation during visits. A broad range of solutions to common and unique challenges are presented in this volume and in the 2004 proceedings.

The following are some of the lessons learned in successfully operating AWS on Quelccaya and Kilimanjaro. The list begins with what might be considered minor-yet-crucial details, and expands in scope toward broader issues.

1. Structural slip-on fittings (e.g., Hollaender Manufacturing) have proven to be strong and reliable. In combination with aluminum tubing, modular towers can be built to accommodate a broad range of uses and mass balance regimes (note extensive use at both stations, in Fig. 1).
2. A supplemental enclosure or "junction box" allows extra sensor wire to be neatly contained, minimizing cable damage, riming, and the temptation to purchase excessively-short cables.

3. "Air terminals" (see Fig. 1) may help to prevent electrostatic problems. At Quelccaya these have proven robust enough to endure frequent rime, although their effectiveness remains anecdotal (i.e., not proven). In a similar situation at Sajama and Illimani AWS without terminals, electrostatic discharge was a considerable problem.
4. Helpful ideas on ultrasonic snow sensors are provided by [Box et al. \(2004\)](#). On Kilimanjaro and Quelccaya, annually changing the transducer has often reduced measurement noise. Both stations utilize identical sensors on opposite sides of the tower, improving data continuity and reducing the influence of small-scale transient anomalies (e.g., snow drifts).
5. At any glacier station, a compelling reason may develop to continue operating the station beyond a relatively-short research interval of several years. For example, the typical research period may inadequately characterize climate variability in some locations, or the initial measurements may reveal unanticipated findings. Designing for an extension of time or measurement scope may prove easy and cost effective, should either become warranted.
6. In some environments, such as at the summit of Quelccaya Ice Cap, thin-film capacitive humidity sensors are not compatible with part-time mechanical aspiration. To save power at the Quelccaya and Kilimanjaro stations, one radiation shield is aspirated prior to each measurement for 2 of every 10 minutes. Under certain radiation, temperature and humidity conditions, water is hypothesized to exist on the sensor when the fan is not operating; ice crystals then apparently grow when the fan is switched on and colder air is introduced over the sensor. It appears that these crystals cause physical damage to the sensor, reducing its surface area and causing a measurement offset (1999, 2009 pers. comm. from Vaisala and Rotronic Instruments, resp.).
7. Air temperature and humidity measurements are difficult over high-elevation, high-albedo surfaces such as glaciers, due to large, diurnally-variable radiation receipt from above and below. Vapor pressure calculations rely upon both. To optimize measurement accuracy, use a shield for which radiation errors over snow and ice are well characterized. If resources permit, replicate air temperature measurements may be valuable, especially if the site permits mechanical aspiration; often sites which present extreme radiation loading (e.g., Kilimanjaro) are also optimal locations for solar power to operate fans. Replicate measurements permit intercomparison studies, and will likely yield a more accurate representation of true temperature and humidity.
8. Instrument calibration is an essential element of measurement accuracy, especially for trend analysis. The need for calibration is especially acute at infrequently-visited AWS in extreme environments. Yet, instrument calibration at glacier stations is fraught with difficulty, as discussed by [Box et al. \(2004\)](#) freshly-calibrated sensors to the site, removing the existing and re-wiring in the new sensor, and then conducting a post-deployment calibration of the sensors taken out. At Quelc-

caya and Kilimanjaro AWS, temperature and humidity sensors are nominally replaced on an annual basis. Although the Pt100 RTD temperature sensor (platinum resistance temperature detector) has remained very stable, the capacitive-type humidity sensor has commonly drifted by  $\pm 2$ -5 percent between calibrations, and more serious shifts of 15-20 percent have been found on several occasions (see lesson #6, above). Without calibration, these changes could have been overlooked, possibly even with replicate measurements.

Finally, field notes and photographs during each visit provide essential documentation that data analysis will rely upon. Our lists of fieldwork objectives are typically long, even overly-ambitious, yet should never compromise careful metadata collection.

### Acknowledgements

Financial support has derived from the U.S. National Science Foundation (Paleoclimate Program) and NOAA (Offices of Global Programs & U.S. Global Climate Observing System). Thanks to many collaborators, guides and porters for field assistance, and to Peruvian and Tanzanian authorities who facilitate the research.

### References

- Box, J., P. Anderson and M. R. van den Broeke. 2004. Lessons to be learned. In: Reijmer, C., editor, *Automatic weather stations on glaciers*, Proceedings of a workshop, 28-31 March 2004, Pontresina (Switzerland), pages 9–28. Institute for Marine and Atmospheric Research Utrecht (IMAU).
- Hardy, D., M. Vuille and R. Bradley. 2003. Variability of snow accumulation and isotopic composition on nevado sajama. *J. Geophys. Res.*, **108**(D22), 4693. Doi: 10.1029/2003JD003623.
- Hardy, D., C. Braun, M. Vuille and R. Bradley. 2004. High-elevation weather stations on glaciers in the tropics and the high arctic. In: Reijmer, C., editor, *Automatic weather stations on glaciers*, Proceedings of a workshop, 28-31 March 2004, Pontresina (Switzerland), pages 52–55. Institute for Marine and Atmospheric Research Utrecht (IMAU).
- Kaser, G., T. Mölg, N. J. Cullen, D. R. Hardy and M. Winkler. 2010. Is the decline of ice on kilimanjaro unprecedented in the holocene? *The Holocene*, **20**, 1079–1091. Doi: 10.1177/0959683610369498.
- Paleoclimate research at quelccaya - image gallery. <http://www.geo.umass.edu/climate/quelccaya/diuc/paleoclimate/index.html>.
- Thompson, L., E. Mosley-Thompson, J. Bolzan and B. Koci. 1985. A 1500-year record of tropical precipitation in ice cores from the quelccaya ice cap, peru. *Science*, **229**(4714), 971–973.
- Thompson, L., E. Mosley-Thompson, M. Davis, K. Henderson, H. Brecher, V. Zagorodnov, P.-N. Lin, T. Mashiotto, V. Mikhalenko, D. Hardy and J. Beer. 2002. Kilimanjaro ice core records: Evidence of holocene climate change in tropical africa. *Science*, **298**(5593), 589–593.
- Thompson, L., E. Mosley-Thompson, H. Brecher, M. Davis, B. L. D. Les, P.-N. Lin, T. Mashiotto and K. Mountain. 2006. Abrupt tropical climate change: Past and present. *Proc. Nat. Acad. Sc. USA*, **103**, 10536–10543. Doi:10.1073/pnas.0603900103.

# Glacier Mass Balance Pods in Wireless Sensor Networks

John Hulth<sup>1</sup> and Johan Strömbom<sup>2</sup>

<sup>1</sup> Department of Mathematical Sciences and Technology,  
Norwegian University of Life Sciences, Ås, Norway  
Email: john.hulth@umb.no

<sup>2</sup> Embsec AB, Täby, Sweden

## Motivation

One of the main uncertainties in surface mass balance estimates is the lack of detailed and geographically unbiased measurements. Simplified assumptions of linear ablation and accumulation gradients are used to calculate area-average mass balances, even on glaciers with relatively dense networks of observations. Uncertainties of when the maximum winter balance and the minimum summer balance occurs, and lack of information of summer snowfalls and winter melt events makes it difficult to couple surface mass balance observations with meteorological records. These problems become larger for regional estimates of glacier mass balance.

In-situ measurements are time consuming and field trips to remote glaciers are expensive. Dense networks of observations with high temporal resolution are required to accurately calibrate and validate mass balance models. These models are needed to improve estimates and projections of run-off and contribution to sea-level rise due to glacier wastage. Therefore, automated methods to continuously measure mass changes have great value in glacier monitoring

## System overview

We have developed a system that continuously measures glacier surface elevation changes due to change in surface mass balance. A number of data acquisition units (Pods) records hourly data of ice melt, snow depth, air temperature and daily average of position. Each unit is installed on a floating platform (Fig. 1a). The only part that is mounted in the ice is the ablatometer wire, which needs to be re-drilled after 15 m of net ablation.

Data are transmitted by radio in a wireless network on a daily basis. Maximum transmission range between two Pods is about 10 km, but with multiple-hop functionality the coverage is basically unlimited. One Pod (the base station) collects data from all other Pods. The base station is equipped with an Iridium modem and forwards data from all other Pods in the network to a central database. Daily updated data and system status are made accessible via the Internet through a Web interface (Fig. 2). Pods are designed to 'survive' three years without maintenance. Units are

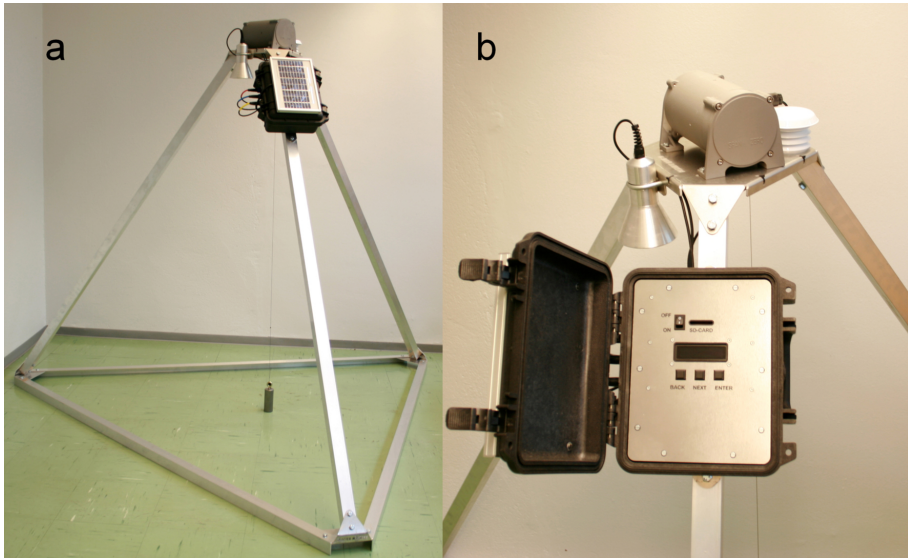

**Figure 1.** Photographs showing (a) the complete setup of a mass balance pod and (b) a close-up of the logger box and instruments.

powered with a small solar panel and internal battery, allowing them to withstand 3-6 months of darkness or being completely covered by snow.

This system has been developed with the goal to provide a 'high-tech' alternative to ablation stakes. We have the first prototypes ready for deployment. Sensors and measurement techniques have previously been tested in similar applications with good results. The added value of continuous measurements, the cost-effective telemetry, and the simplicity of installation and data handling, will make this system an interesting alternative to traditional glacier monitoring methods.

## Sensors

A new method was developed by [Hulth \(2010\)](#) to accurately measure surface change due to net ablation with a draw-wire sensor (Fig. 1b). This approach provides high precision and temporal resolution ablation measurements and eliminates the problem of stakes melting out or bending. It can operate without need of re-drilling for several ablation seasons depending on melt rate and the length of the wire.

We have constructed a low-cost sonic ranger (Fig. 1b), which is compatible with most data loggers, to measure distance to the snow surface. Distance readings in combination with the known installation height are converted to snow depth relative to the prior summer surface. Maximum measurement range is limited by the installation height and recommended to 2 m for practical reasons. The resolution of the sensor is 1 cm.

Air temperature is measured inside an unventilated radiation shield (Fig. 1b). These measurements are also used to compensate the distance

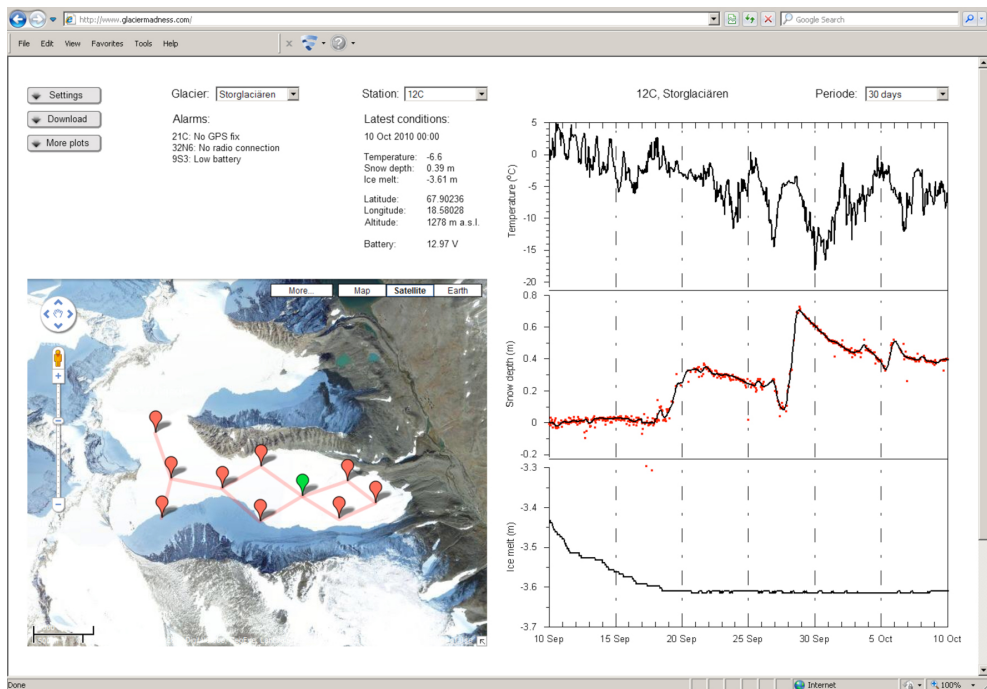

**Figure 2.** Illustration of the Web interface. Collected data are stored in a central database and accessible through a Web interface and downloadable directly from the webpage. Data presented are for illustrative purpose, though being authentic and collected at Kahiltna glaciers, Alaska, and Sørbreen, Jan Mayen, during testing of the instruments and measurement techniques. Storglaciären is shown in the Google map image to illustrate how a network of Pods could be organized on a glacier. (Data of snow depth and air temperature belongs to A. Arendt and J. Young, UAF).

reading by the sonic ranger. Location of the Pod is recorded with a single-frequency GPS receiver. The precise time information of the GPS system is used to synchronize the real-time clock in the pod.

## System advantages

- Delivers detailed point mass balance data
- Robust and easy to install
- Designed to operate 3 years without maintenance
- Reduces field expenditures
- Incorporates a new promising type of ablatometer
- 10 km transmission range in mesh network
- Reduces the cost for satellite telemetry service
- Provides a daily updated database of collected data
- Easy sharing of data through Web interface

## References

Hulth, J.. 2010. Using a draw-wire sensor to continuously monitor glacier melt. *J. Glaciol.*, **56**(199), 922–924.

# A versatile tower platform for glacier instrumentation: GPS and Eddy Covariance Measurements

Alexander H. Jarosch<sup>1</sup>, Faron S. Anslow<sup>2</sup>, Joseph Shea<sup>3,4</sup>

<sup>1</sup> Centre for Climate and Cryosphere, University of Innsbruck, Austria.  
Email: Alexander.Jarosch@uibk.ac.at

<sup>2</sup> Pacific Climate Impact Consortium, University of Victoria, Canada.  
Email: fanslow@uvic.ca

<sup>3</sup> Department of Geography, University of British Columbia, Canada.

<sup>4</sup> Department of Geography, University of Northern British Columbia, Canada.  
Email: joseph.shea@geog.ubc.ca

## Introduction

Deploying a high accuracy, kinematic GPS on a glacier to measure surface movements over time creates specific demands on the design of the mounting platform. First, the platform must be anchored directly to the ice surface to ensure that the GPS device actually measures ice deformation. Second, accumulation throughout the winter season dictates that the instrument must be mounted at a certain height above the ice surface to avoid burial by snow. Third, to ensure a direct coupling between the instrument and the ice surface, a very rigid mounting structure is required, which minimizes the interference of structural instabilities (e.g. vibration or swaying) with the measurement of ice surface motion. Finally, the design should be easily expandable, modular, only require off-the-shelf components, allow for easy assembly in the field, and require a minimum of custom fabrication.

## Tower Design and Assembly

Inspired by the requirements laid out in the introduction, we describe the design of our tower platform which was initially intended for GPS measurements. We also present the utilization of the tower for eddy covariance measurements. As the main building material for the tower we choose 1 1/2" IPS (48 mm outer diameter) aluminum tubing, which fits perfectly into bore holes from a standard ice auger, is structurally very rigid, and readily available. To create a rigid structure, we connect tube segments of different length with standard industrial fittings as displayed in Figure 1. The following parts are required for building the basic tower:

- 3 x 4 m, 1 1/2" IPS aluminum tubing as anchors (vary these depending on ablation).
- 3 x 2-3 m, 1 1/2" IPS aluminum tubing for tower (vary these depending on accumulation).
- 9 x 0.5 m, 1 1/2" IPS aluminum tubing for cross bracing.
- 3 x NuRail<sup>®</sup> #70-8 connectors to couple anchors to tower.



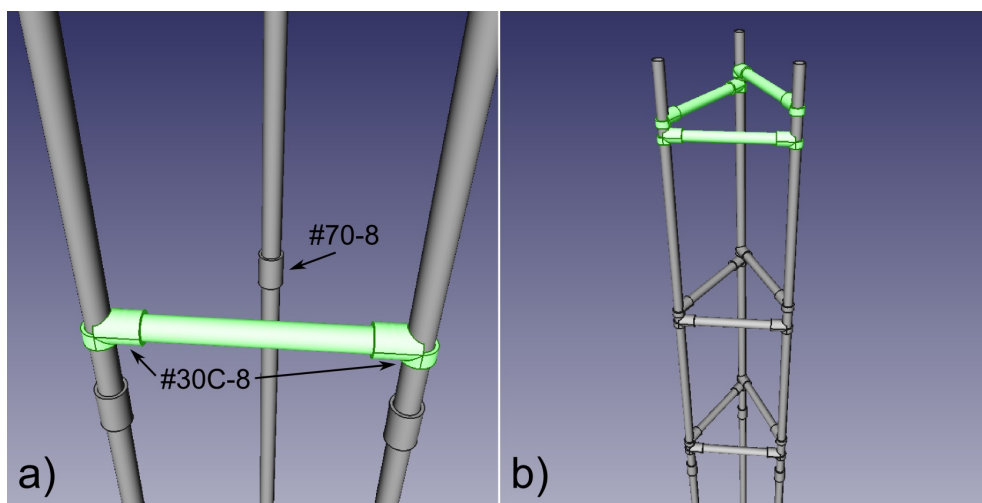

**Figure 1.** A cross brace element of the tower is displayed in (a) and the whole tower setup in (b).

- 9 x NuRail® #30C-8 connectors for cross bracing.

Additionally one can use:

- 3x NuRail® #40-8 flanges to mount the custom top antenna plate.
- 4x NuRail® #7-8 crosses to mount the solar panel.

The vast amount of readily available industrial connectors allows for flexible design solutions, which should be suitable for many glaciological solutions. Assembly of the tower in the field is straight forward and one can use our routine as a guideline:

- Drill three holes vertically in the ice, which fit the three anchor poles and use an assembled cross brace (Fig. 1a) as a distance template between the holes. A water level designed to mount on pipes proved itself to be very useful for vertical drilling.
- Add the three #70-8 connectors to the anchors and mount the three tower poles.
- Use one set of #30C-8 connectors and a 0.5 m pipe segment to build a cross brace.
- Slide three cross braces onto the tower poles to create one level of cross bracing.
- Add three levels of cross bracing to the tower.
- Additionally add a custom top plate and/or the solar panel mounts (#7-8 in our case).

The finished tower can now be instrumented and auxiliary booms can be easily mounted to the rigid structure. Resetting of the tower after a year in the field is simple. One can just unmount the tower from the anchors by opening the #70-8 connectors and the anchors can be re-drilled or one

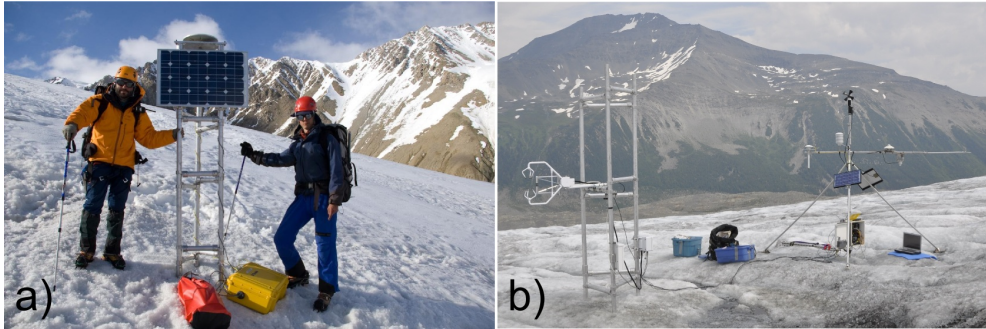

**Figure 2.** GPS tower setup located in Kluane National Park (a) and the eddy covariance setup at Castle Creek Glacier (b).

uses another set of anchor poles to set up the tower beside the old location. Normally two sets of anchor poles are sufficient as the old anchors normally melt out of the ice over the next year.

For GPS applications in Kluane National Park (see Fig. 2), we did not find the need to plug the anchor poles to prevent sinking over time, but this depends on the load of the tower and could easily be done. For the eddy covariance application, large cork stoppers were inserted into the end of the anchor poles and secured with tape. As the poles were inserted into water-filled holes, it became necessary to cut holes into the cork to allow water and air pressures to equilibrate.

### GPS Application

Our tower design is used to measure surface movements on a glacier ( $60^{\circ}49'20''$  N,  $139^{\circ}7'26.8''$  W) in the Kluane National Park, Yukon, Canada, instrumented with Trimble<sup>®</sup> R7 receivers together with Zephyr Geodetic antennae, which are mounted with a custom made top plate onto our towers (cf. Fig. 2a). To provide power for a year round operation of the instruments, we use 100 Ah deep-cycle AGM batteries at each tower which are recharged by 50 W solar panels. This setup allows us to measure for 6 hrs each day (9 am to 3 pm local time) at a 1 Hz sampling rate. We limit the measurement time because of little sunlight and cold air temperatures during the winter months which both have negative effects on the battery charge. With this setup several instruments have been measuring glacier motion continuously since 2008 at the field site of G.E. Flowers and C.G. Schoof. So far we have not encountered major difficulties or design flaws during the 3 years of operation.

### Eddy Covariance Application

In the summer of 2010, this tower design was tested as a mounting platform for open path eddy covariance (OPEC) measurements on Castle Creek Glacier ( $53^{\circ}2.2'$  N,  $120^{\circ}24.4'$  W) in the Cariboo Mountains of British Columbia, Canada. A sonic anemometer (CSAT-3) and krypton hygrometer (KH-

20) were installed on the tower structure, with an initial height of 1.86 m above the ice surface. The CSAT-3 was oriented to minimize turbulence with the tower structure, with the x-axis perpendicular to the dominant down-glacier (katabatic) wind direction. OPEC measurements were collected at a frequency of 20 Hz, and stored on a 2 GB compact flash card using a Campbell® Scientific SC-115 flash storage attachment on the CR1000 datalogger. Near-continuous measurements were collected between August 2<sup>nd</sup> and August 10<sup>th</sup>, before power issues interrupted the datalogger operation. Two 10 W solar panels were used to trickle charge the 12 V batteries, but cloudy conditions during the observation period limited the battery recharge. Voltages dropped below 10.5 V during the night of August 10<sup>th</sup>, 11<sup>th</sup> and 12<sup>th</sup>, and the datalogger function stopped completely on August 13<sup>th</sup>. Despite the power supply issues, very useful data has been collected and the tower proved itself to be a very stable mounting platform for eddy covariance measurements over a glacier surface. At a sampling frequency of 20 Hz, the flash card memory allows for approximately 30 days of observations. At high-melt locations, this may be the limit that the tower can be left unattended. For long term measurements we suggest to use 100 Ah deep-cycle AGM batteries and 40-50 W solar panels, which should allow for an operation of the instruments for several months.

## **Conclusions**

We found the above described tower design to be very suitable for GPS and eddy covariance measurements above glacier surfaces. The design is readily available, only uses off-the-shelf components and can be easily modified to be suitable for many other glaciological applications. Finally, we hope others find this design useful for mounting their instruments and we would be delighted to answer questions or discuss the design further via email.

# New AWS activities in Antarctica started by the Alfred Wegener Institute

Bernd Loose

Climate Sciences / Polar Meteorology / Meteorological Observatories,  
Alfred Wegener Institute for Polar and Marine Research in the Helmholtz Association  
Email: Bernd.Loose@awi.de

In some parts of Antarctica, mainly in the region of the Antarctic Peninsula, warming of the lower atmosphere over the past decades is well documented. But is there also such a trend in other regions of the continent? [Steig \*et al.\* \(2009\)](#) claim that the continent-wide average near-surface temperature trend is positive. At Neumayer Station on the Ekström ice shelf (70°40'S, 8°16'W), the Alfred Wegener Institute operates a meteorological observatory since 1981. The time series of air temperature from that observatory does not show significant warming or cooling over this period of nearly thirty years. Measurements from a single station are naturally not representative for the whole continent. Nevertheless an internal discussion on accuracy and reliability of AWS started because their data is an important basis for climatological analyses. These systems are often unattended over years. Their sensors and measurements are affected by many environmental influences such as coldness, storms, icing, snow accumulation, solar radiation and so on, which will reduce the quality of



**Figure 1.** The AWI AWS near Neumayer III. (Photo: Jölund Asseng)

their data. To achieve answers upon the open questions, it was decided to install an AWS which should be composed mainly of widespread standard components. Only a sufficient thermistor chain could not be found on the market. Therefore an in-house development was made and is now a well functioning part of the AWS.

The routine measurements with the new AWS started on 24<sup>th</sup> January 2011 close to the meteorological tower of the observatory of the research station Neumayer III. During the first year of operation, we focus on the behavior of the meteorological sensors. To assure an easy and uninterrupted data retrieval, we installed a permanent connection to external power and the network of the station. The meteorologist monitors the function of the AWS during this year and will document all particular events. The short distance to the sensors of the meteorological observatory and the permanent control by the operator enables an optimal comparison between the two systems. At the end of the year it should be possible to make reliable statements on the quality of the AWS data.

### **Components of the AWS:**

- **Air pressure:**  
R.M. Young barometric pressure sensor, Type: 61302V
- **Wind speed and direction:**  
R.M. Young Wind Monitor-MA, Type: 05106-5
- **Relative humidity and air temperature:**  
Vaisala Humidity and Temperature Probe, Type: HMP155 which is mounted inside a Campbell Scientific Unaspirated Radiation Shield, Type: MET 21
- **Short- and longwave radiation components and balances:**  
Kipp & zonen Net Radiometer, Type: CNR4
- **Snow height:**  
Campbell Scientific Ultrasonic Snow Height Sensor, Type: SR50A
- **Snow temperature profile:**  
Self developed thermistor chain, 15 Pt100 from -10 m to 1 m

First comparisons between the different data sets show already several discrepancies which are not negligible. Details will be described later and shall lead to improvements in the instrumentation of the AWS. The development of effective validation routines is also a task of the project.

Until January 2012 it is intended to sample the data of the AWS over a period of one year at its current position. This one year record will be the basis for calculating the differences to the data from the observatory in mean and for selected weather situations. Meanwhile wireless data transmission equipment and a photovoltaic solar power supply will be chosen and purchased.

In January 2012 during the Antarctic summer campaign, the AWS will be disassembled and transported to a new position about 20 km north from

Neumayer III. Hence it will be still accessible for maintenance after a short ride by scooter. At this more remote position the testing of the system will continue. Especially the function of the new components is of interest. Improvements are likely necessary to be done in future years.

### **Scientific work for the coming years:**

#### **Climatology of the Ekström ice shelf:**

The climatological conditions on the Ekström ice shelf are inhomogeneous. The influence of the ocean decreases with increasing distance from the ice edge. An additional AWS on the fast ice of the Atka Bay together with the meteorological observatory should allow for spatially distributed observations of the weather in this region. The data is also supposed to be used for modeling the regional climate of the Atka Bay.

#### **Validation of Radar satellite pictures:**

High resolution radar satellite pictures are very helpful for the observation of ice movement and sea ice coverage. But the accurate interpretation of such pictures is complicated. In particular the snow accumulation data could help to improve the interpretation.

#### **Meteorological surface data for drilling sites:**

For better interpretation of firn and ice cores it is important to get surface data over several years from the neighborhood of the boreholes. It is likely that the meteorological observatories group will work together with our glaciologists if they intend to install AWS in selected regions where AWI drilling projects will be carried out.

### **References**

Steig, E., D. Schneider, S. Rutherford, M. Mann, J. Comiso and D. Shindell. 2009. Warming of the antarctic ice-sheet surface since the 1957 international geophysical year. *Nature*, **457**, 459–463.

# Eddy covariance measurements on semi-arid Andean glaciers: power, memory and penitentes

Shelley MacDonell

Centro de Estudios Avanzados en Zonas Áridas, La Serena, Chile  
Email: shelley.macdonell@gmail.com

Penitentes, or ice/snow pinnacles, are one of the most characteristic features of glaciers in the Norte Chico region of Chile (Fig. 1). The formation of penitentes is the result of differential ablation, and is a clear sign of the dominance of incoming shortwave radiation and the latent heat flux in the energy balance (Lliboutry, 1954; Amstuz, 1955; Kraus, 1972; Lliboutry, 1998; Kaser *et al.*, 2004; Betterton, 2001; Schulz and de Jong, 2004; Bergenon *et al.*, 2006). Penitentes begin to form due to high sublimation rates in environments where the dew point is below zero. However, the exact triggers of formation, and the rates of development remain unknown. The presence of penitentes makes it difficult to calculate ablation on a glacier, because not only does their complicated topography mean that they receive solar energy in a different way to a simple planar surface, but they also modify the glacier boundary by modifying turbulence over the glacier. Whilst many studies have made considerable progress in the understanding of penitente and climate interactions (for example: Corripio and Purves, 2005), we are still unable to properly account for penitente processes within mass balance models. The first step for the development of a physically-based mass balance model that accounts for penitente processes is understanding their effect on the turbulent heat fluxes. To accomplish this aim, a dedicated eddy covariance measurement scheme is being used to continuously measure the turbulent heat fluxes over a developing penitente field, although primarily due to problems with power supply, this system has only been able to successfully record isolated days of data. This abstract will briefly outline the system setups used thus far, and will report on the recommendations discussed during the meeting that will be used for future trials.

Thus far, five different power setups have been trialled with varying degrees of success to charge a CSAT3 sonic anemometer, a LI-COR7500 gas analyser and CR1000 datalogger logging at 10 Hz (Tab. 1). Whilst these setups were sufficient to run the system for a week, they did not supply sufficient power to keep the system running for longer periods. Of the five setups, the most 'successful' (i.e. the system had sufficient power for several days) were the first and third options, where relatively large batteries were connected to a 60 W panel.

The consensus view from discussions at the workshop was that the solar panel was probably not sufficient enough to charge the battery given



**Figure 1.** Penitentes on the surface of a small glacier in the Huasco Valley, Chile in January 2011. The photo shows a field of penitentes that are between 1.5 - 2 m high (easterly view). Note the person in the background for scale.

the relatively large current needed to power the LI-COR7500 gas analyser. The recommendations were to either add another 60 W panel to Setup 3 and to possibly add more battery power (i.e. 2 x 60 W panels and batteries totalling 200 Ahr). To achieve this level of battery capacity it was recommended to use four or more smaller batteries in parallel as opposed to one large battery, as smaller batteries are easier to manage in the field). A 20 A diode to regulate each solar panel was suggested as an alternative to the regulator as they are more economical, easier to test and acquire. Finally, the measurement interval could be decreased to 1 Hz to reduce power requirements without losing information relevant to the turbulent flux measurements.

This coming winter I plan to trial the new power system options, and will hopefully have the system running continuously before the penitentes start to grow again!

**Table 1.** Power system trials

Setup ID	Power setup
1	110Ah battery + 60 W panel + Morning star SunSaver 10 regulator
2	150Ah + 60 W panel (connected at day)
3	150Ah + 60 W panel + diode
4	110Ah + 150 Ah (parallel)
5	150Ah + 2*10 W panel + SunSaver / Campbell 9 Ah regulator



## Acknowledgements

Special thanks to Michele Citterio, Paul Smeets, Alex Jarosch, Lindsey Nicholson, and Christophe Kinnard for helpful discussions.

## References

- Amstutz, G.. 1955. On the formation of snow penitentes. *J. Glaciol.*, **3**(24), 304–311.
- Bergenson, V., C. Berger and M. Betterton. 2006. Controlled irradiative formation of penitentes. *Physical Review Letters*, **96**(098502).
- Betterton, M.. 2001. Theory of structure formation in snowfields motivated by penitentes, suncups, and dirt cones. *Physical Review E*, **63**(056129).
- Corripio, J. and R. Purves. 2005. Surface energy balance of high altitude glaciers in the central andes: the effect of snow penitentes. In: de Jong, C., D. Collins and R. Ranzi, editors, *Climate and Hydrology in Mountain Areas*. Wiley & Sons, London.
- Kaser, G., D. Hardy, T. Mölg, R. Bradley and T. Hyera. 2004. Modern glacier retreat on kilimanjaro as evidence of climate change: observations and facts. *Int. J. Climatol.*, **24**, 291–303.
- Kraus, H.. 1972. Energy exchange at air-ice interface, in role of snow and ice in hydrology. *IAHS Pub.*, **107**, 128–164. IAHS Press, Wallingford.
- Lliboutry, L.. 1954. The origin of penitentes. *J. Glaciol.*, **2**(15), 331–338.
- Lliboutry, L.. 1998. Glaciers of the dry andes. In: Williams, R. S. J. and J. G. Ferrigno, editors, *Satellite Image Atlas of Glaciers of the World SOUTH AMERICA*. Professional Paper 1386-I. United States Geological Survey.
- Schulz, O. and C. de Jong. 2004. Snowmelt and sublimation: field experiments and modelling in the high atlas mountains of morocco. *Hydrology and Earth System Sciences*, **8**(6), 1076–1089.

# Glaciological field studies at Zhadang Glacier (5500-6095 m), Tibetan Plateau

Fabien Maussion<sup>1</sup>, Yang Wei<sup>2</sup>, Eva Huintjes<sup>3</sup>, Tino Pieczonka<sup>4</sup>, Dieter Scherer<sup>1</sup>, Tandong Yao<sup>2</sup>, Shichang Kang<sup>2</sup>, Tobias Bolch<sup>4</sup>, Manfred Buchroithner<sup>4</sup> and Christoph Schneider<sup>3</sup>

<sup>1</sup> Institut für Ökologie, Technische Universität Berlin, Berlin, Germany

Email: fabien.maussion@tu-berlin.de

<sup>2</sup> Institute of Tibetan Plateau Research, Chinese Academy of Sciences, Beijing, China

<sup>3</sup> Geographisches Institut, RWTH Aachen University, Aachen, Germany

<sup>4</sup> Institut für Kartographie, Technische Universität Dresden, Dresden, Germany

## Introduction

For historical and logistical reasons, meteorological observations on the Tibetan Plateau (TP) are scarce. It is even more true for mountain-regions, where glaciers have been observed intensively only since recent years. This lack of observations is problematic, regarding their importance for both local and regional ecosystems. Primarily, the Institute of Tibetan Plateau Research (ITP, Chinese Academy of Sciences) is dedicated to current glaciological observations on the TP.

Zhadang Glacier is a small valley glacier (2.48 km<sup>2</sup>) located in the Nyainqentanglha Range, about 200 km North from Lhasa (see Fig. 1 and [Bolch et al. \(2010\)](#), for a comprehensive description of the study region and its glacier changes 1976-2009). The glacier is exposed to the northwest and drains into Lake Nam Co (4725 m a.s.l.), Tibet's largest salt water lake. The region is under the complex influence of both the continental climate of Central Asia and the Indian Monsoon system ([Kang et al., 2009](#)), which leads to a climate characterised by a strong seasonality in both temperature and precipitation. Only little precipitation occurs during winter, while about 90% of mean annual precipitation is measured from June to September. Glaciers located in this continental summer precipitation climate, with the maximum of annual accumulation and ablation occurring simultaneously, are called summer accumulation type glaciers.

ITP operates two Automatic Weather Stations (AWS) since September 2005 in the area of Zhadang Glacier: one in the accumulation area of the glacier (5785 m a.s.l.) and the other in the valley (5400 m a.s.l.) in front of the glacier. Continuous measurements are supplemented by mass balance measurements applying the glaciological method. The installations have been complemented in May 2009 by Sino-German teams within the DynRG-TIP project ([Link](#)) with two AWS: one on the ablation zone of the glacier (5660 m a.s.l.) and one that has been relocated recently to the terminal moraine close to the glacier tongue (5550 m a.s.l.). Besides, two time-lapse cameras have been installed in May 2010 (Fig. 1). This makes Zhadang Glacier to be the one of the most sophisticated measurement

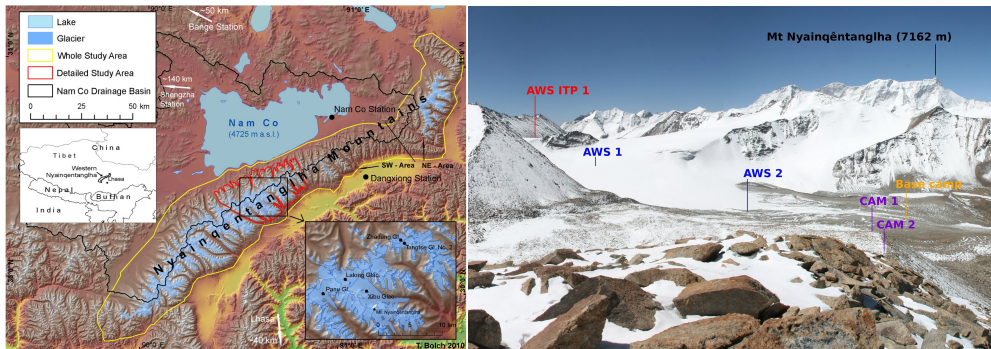

**Figure 1.** a) Overview of the Nyainqentanglha Range, including a zoom into the Zhadang Glacier area (after Bolch *et al.*, 2010). b) Panorama of Zhadang Glacier, with locations of the AWS and camera installations (full panorama available online ([Link](#)))

sites on the TP. Here we focus on the recent DynRG-TiP AWS and camera installations.

### Logistical aspects

The equipment and mechanical parts have been shipped from Germany to China a few months before our arrival. The Chinese customs allow a temporary import for a period of six months renewable only twice, and ask for a security deposit of about 20% of the ware value. Since our stations operate for a longer period, the deposit has been lost and the ware was officially imported to China in 2010. Some useful mechanical parts (tools, tubes, etc.) can be bought in Lhasa, but they are mostly of inferior quality or heavy.

We usually visit the glacier twice a year (May and September). However, this will no longer be necessary as the systems are now running stable. We expect that one campaign per year towards the end of the ablation season will be sufficient. Due to the high altitude two acclimatisation steps of three days each are necessary (Lhasa, 3650 m.a.s.l. and Nam Co, 4740 m.a.s.l.) before being capable to go up to the base camp (5400 m.a.s.l.), which is reached in a one day walk. Tibetan nomads are living in the valley from May to September and let their yaks graze. Without their support and the strength of their horses or yaks to carry our equipment, the ascension would be virtually impossible. However, the nomads are not always in favour of our activities: some of them are superstitious and recently our stations were held responsible for various capricious weather phenomena.

### Automatic weather stations

The instruments (Tab. 1) were primarily mounted on a mast drilled into the ice to more than 2.5 m depth. Based on the mass balance measurements

**Table 1.** Sensor specifications.

Measured quantity	Instrument	Sample interval
Air temperature (2 heights)	CS215 (Campbell)	10 min
Relative humidity (2 heights)	CS215 (Campbell)	10 min
Air pressure	DPI740 (T. Friedrichs & Co)	10 min
Net radiation	NR-Lite (Campbell)	10 min
Solar radiation (up and down)	CS300 (Campbell)	10 min
Longwave radiation (up)	IRTS-P Apogee	10 min
Ice temperature (8 depths, down to 9 m)	107TP (Campbell)	10 min
Surface height	SR50 (Campbell)	10 min
Wind speed and direction	05103 (Young)	10 sec sample, 10 min storage
Wind (sonic anemometer)	Windmaster (Gill)	10 Hz sample, 10 min storage
Mast inclination (2D)	SCA121T (VTI Tech)	10 min

in previous years (about 1 m w.e. per year, [Kang et al. \(2009\)](#)) and our own estimation of the equilibrium line altitude, this seemed to be a reasonable choice. The high ablation in 2009, estimated to 2.5 m of ice, caused the fall of both stations around mid-July. Therefore, we changed to a tripod set-up and a separate mast for the sonic ranger (Campbell SR50) (Fig. 2). The stations was supposed to stay on their feet as the ice level decreases but for some reasons (extreme wind? debris within the ice?) the stations again fell over in summer 2010. ITP staff could re-erect them one month later. A construction with wider feet extent may have been more stable, but difficult to find in China. The SR50 structure inspired by [Oerlemans et al. \(2004\)](#) (three tubes of 5 m length, drilled inclined into the ice) proved to be very stable, but the inclined holes are difficult to drill properly using the steam drill.

The stations worked perfectly and had no data or power failures (radiation values are high also in winter and the batteries are recharged efficiently). Thanks to the inclinometer placed at the mast, it was easy to track all events of falling over. By this means valid measurement periods could be selected. The low-cost of the sensor is less of a problem than the provision of two extra slots on the data-logger (CR1000, Campbell). Nevertheless, this is really worthwhile considering the importance of the information on mast tilt. In order to measure the radiation budget we replaced the popular CNR1 from Kipp & Zonen by the cost-effective 4-sensor installation described in Table 1. The shortwave radiation measurements proved to be accurate. In contrast, the longwave radiation measurements were not satisfying for two reasons. The IRTS sensor shows high sensitivity to solar radiation and measured snow surface temperatures up to several K above the melting point during the day. Furthermore, incoming longwave radiation (obtained using the net radiation value subtracted from the three measured components) suffers from accuracy problems due to the different frequency responses of the various sensors. Two temperature and relative humidity (RH) probes are placed in a ventilated radiation

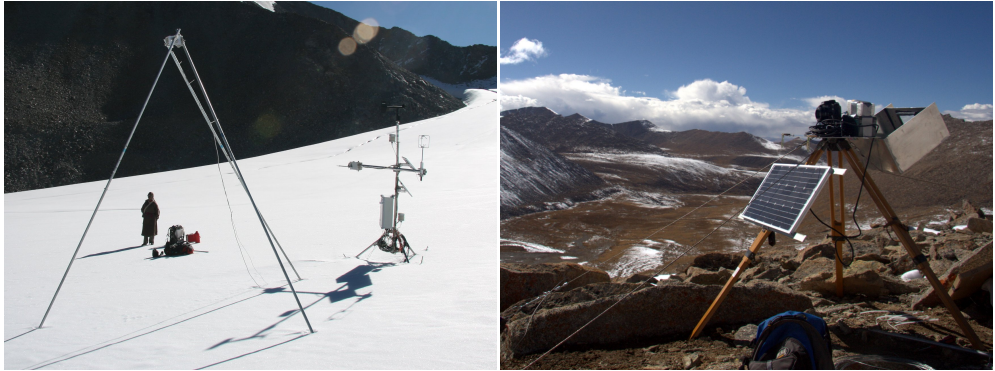

**a.**

**b.**

**Figure 2.** a) The AWS 1 in autumn 2010 and our young Tibetan helper. b) The terrestrial camera system (placed in a waterproof box that is closed afterwards)

shield (THIES Clima GmbH). The ventilators are directly connected to two solar panels in an independent circuit. This has the strong advantage that the ventilator will not use the power of the battery and that the probes are efficiently ventilated during the day. However, there is the disadvantage that the probes are not ventilated at night. The solar panel voltage is sampled every 10 minutes to track the strength of ventilation. The effect of this ventilation strategy in comparison with permanent ventilation needs to be evaluated in more detail.

### Terrestrial cameras

We installed two cameras on the glacier lateral moraine (Canon EOS D-60, objective of 28mm focus, fixed aperture value of 7.1 and adaptive aperture time) taking three (recently changed to six) pictures a day of the glacier tongue area. The power supply for each camera and the camera timer, responsible for the triggering impulse, is ensured by a single 12V battery recharged by a solar panel. Because both cameras (base of about 400 m with a base-to-height ratio of about 0.3) are operating simultaneously it is possible to compute glacier volume changes using stereoscopy. Therefore, 14 Ground Control Points (GCPs) were measured in the glacier forefield. As point locations we chose single boulders which are supposed to be stable over time. Even though one of the cameras was stolen in summer 2010, the second camera provided a dataset of high quality (animation available online ([Link](#))). The pictures allow a rare insight into the meteorological and surface conditions of the glacier on a sub-daily basis, which is useful for AWS data processing, analysis and validation. For example, the image time series was analysed in order to produce a dataset of the timing and intensity of snow events which was used for the validation of the sonic ranger snowfall algorithm.

## **Data treatment**

During winter, the tripod feet are covered by ice and snow and the system is very stable. Only standard corrections are necessary (RH for temperatures below zero using the values given by Campbell, interpolation of temperature and humidity at the 2 m height, sonic range correction for temperature). During summer, rapid snow events and follow-up melt may occur within hours. High wind speeds and surface changes make the station stagger.

Precipitation often occurs in the form of soft hail. All these surface conditions together seem to influence the quality of the signal of the sonic ranger. The quality flag provided by the sensor is useful for automatically filtering a large part of the invalid data. Nevertheless, the signal remains noisy (sometimes above the accuracy of 1 cm specified by the manufacturer) especially during precipitation events. The temperature correction is necessary to avoid artefacts, as the measured distance may "diminish" at the end of the day. This could falsely be interpreted as a snow event. In order to minimise this effect, a 3 h moving mean of top and bottom temperature sensors was used for the correction. Finally, a 3 h moving mean is applied to the sonic ranger data for noise reduction. A larger window size would increase the smoothing but would reduce the signal of the short and small (less than 10 cm) but frequent snow events of the summer season.

For the detection and quantification of snow events using sonic ranger data, several algorithms were compared and gave largely variable results (up to a factor 3 in the amounts). The main issue is that no validation can be made without a reference dataset. Using the information provided by the time-lapse camera as reference, one of the algorithms could objectively be selected. The 6 hourly snowfall amount is obtained as follows: if the mean surface height (snow depth) of the 6 h period is higher of at least 1 cm than the mean surface height of the previous 6 h, then a snow event occurred. The 6 h snowfall is given by the difference between the maximum and the minimum surface height during these 6 h.

## **Recommendations and conclusions**

In this document, we presented the operation of two AWS and two cameras in the harsh environment of the TP. We addressed several topics such as logistics, instrumentation, mechanical construction and data treatment. In general, our field experiment is a success, but we also made several mistakes that we would like to share in the following list of recommendations. They are based on our own experience, and may be not entirely new or even be unsuitable for other environments.

- Despite the high altitude, ablation is very strong on glaciers of the central TP. The ablation season is short (June to mid-August) but intense. Therefore, AWS constructions based on stable tripods are recommended for altitude ranges below 6000 m a.s.l.

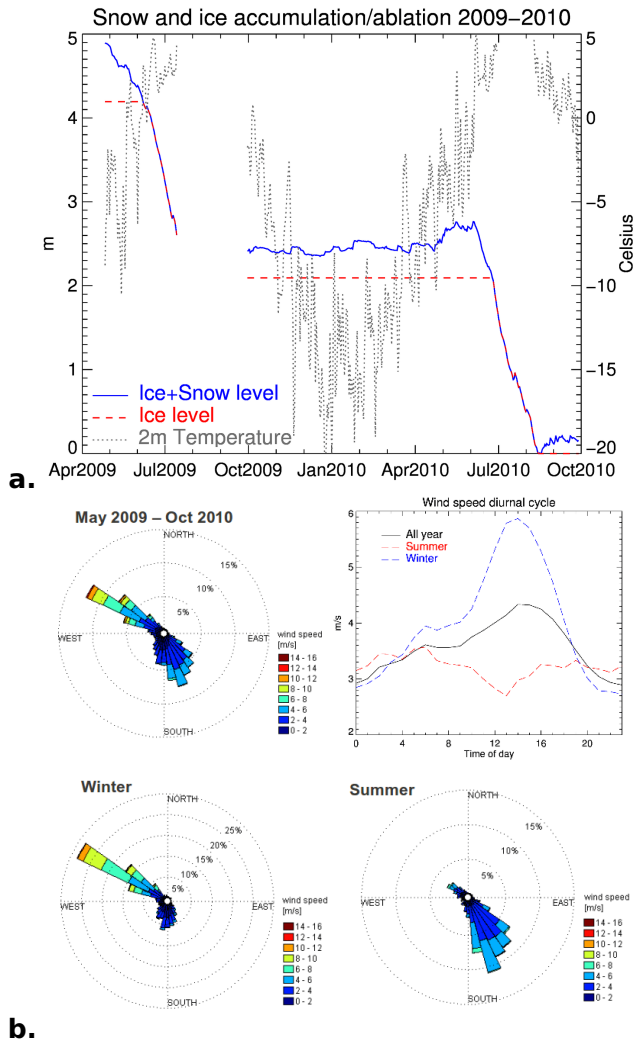

**Figure 3.** a) Daily means of snow accumulation and ablation at AWS 1 in 2009 and 2010 and air temperature. b) Wind roses and diurnal cycle of wind speed for the whole measurement period, winter season and summer season.

- The tripod should be as light and as bright as possible to resist the harsh weather conditions.
- A second system, installed next to the glacier, emerged as the safest way to ensure continuous data collection.
- Time-lapse cameras, besides the application for stereoscopy, are a useful tool to understand and observe surface and near-surface conditions of a glacier. Cost-effective systems are easily available for such purposes.
- The "daytime ventilation", radiation shield ventilators directly connected to independent dedicated solar panels, is an efficient way to ensure the

power supply of the instruments. The effect of this ventilation strategy on the temperature measurements especially during night is not yet quantified.

- If there are adequate financial resources, a direct measurement of all four radiation components using accurate sensors is a good solution to avoid complex and imperfect data post-processing.
- If there are enough slots available on the data-logger, the measurement of the tilt of the mast simplifies many aspects of data post-processing.
- The signal quality flag provided by the SR50 sensor provides useful information for efficient data filtering. There should be a memory slot reserved on the data logger for this number if ever possible.

The authors will be pleased to answer any further questions and are open to suggestions or comments regarding this list.

In the meantime, the efforts of measuring near surface meteorology on Zhadang Glacier have provided us with outstanding and unique data (see Fig. 3) that in the near future will allow accurate and state-of-the-art investigation of surface energy and mass exchange from a logistically difficult remote high altitude site.

## Acknowledgements

The work is supported by the German Research Foundation (Deutsche Forschungsgemeinschaft, DFG) within the Tibetan Plateau (TiP) Priority Programme under the codes SCHE 750/4-1, SCHN 680/3-1, and BU 949/20-1. Many thanks to our colleagues from the ITP, from Germany and to our Tibetan helpers.

## References

- Bolch, T., T. Yao, S. Kang, M. Buchroithner, D. Scherer, F. Maussion and C. Schneider. 2010. A glacier inventory for the western nyainqentanglha range and nam co basin, tibet, and glacier changes 1976–2009. *The Cryosphere*, **4**, 419–433.
- DynRG-TiP. Dynamic response of glaciers on the tibetan plateau to climate change ([http://www.klima.tu-berlin.de/index.php?show=forschung\\_asien\\_tibet &lan=en](http://www.klima.tu-berlin.de/index.php?show=forschung_asien_tibet&lan=en)). *DFG Priority Programme 1372*. “Tibetan Plateau: Formation, Climate Ecosystems (TiP)” (<http://www.tip.uni-tuebingen.de>).
- Kang, S., F. Chen, T. Gao, Y. Zhang, W. Yang, W. Yu and T. Yao. 2009. Early onset of rainy season suppresses glacier melt: a case study on zhadang glacier, tibetan plateau. *J. Glaciol.*, **55**(192), 755–758.
- Oerlemans, J., W. Boot, M. van den Broeke, C. Reijmer and R. van de Wal. 2004. Aws in the ablation zones of glaciers, workshop on the use of automatic weather stations on glaciers. In: Reijmer, C., editor, *Automatic weather stations on glaciers*, Proceedings of a workshop, 28–31 March 2004, Pontresina (Switzerland), pages 83–87. Institute for Marine and Atmospheric Research Utrecht (IMAU). [http://www.projects.science.uu.nl/iceclimate/workshop/documents/aws\\_abstracts.pdf](http://www.projects.science.uu.nl/iceclimate/workshop/documents/aws_abstracts.pdf).
- One ablation season at zhadang glacier. [http://www.klima.tu-berlin.de/forschung/Asien/tibet/pics/one\\_season.gif](http://www.klima.tu-berlin.de/forschung/Asien/tibet/pics/one_season.gif).
- Panorama of zhadang glacier. [http://www.klima.tu-berlin.de/forschung/Asien/tibet/pics/panorama/zhadang\\_pano.html](http://www.klima.tu-berlin.de/forschung/Asien/tibet/pics/panorama/zhadang_pano.html).



# Determining glacier velocity with single frequency GPS receivers

C.H. Reijmer, R.S.W. van de Wal and W. Boot

Institute for Marine and Atmospheric research Utrecht, Utrecht University, The Netherlands.

## Introduction

A well-known phenomenon in glacier dynamics is the existence of a relation between the glacier velocity and available amount of melt water (Zwally *et al.*, 2002; Van de Wal *et al.*, 2008). This relation is of particular importance when estimating the reaction of glaciers and ice sheets to climate change. In order to better understand this relation, detailed flow velocity and mass balance information is crucial. For this purpose, the Institute for Marine and Atmospheric research Utrecht (IMAU) developed a low cost stand-alone single-frequency GPS unit to perform year round ice velocity observations.

## The Instruments

The GPS units make use of the Global Positioning System (GPS) (United States Air Force, 1996; USA Department of Defence, 2008), to determine the location of an instrument at a preset time interval. GPS is available since 1973 and since in 2000 the selective availability (an artificial degrading of the signal) is turned off, the stand-alone system is commercially developed for navigational purposes. In 2003 IMAU started the development of a cheap and robust GPS receiver to monitor glacier velocities. Figure 1 presents the unit. It consists of a small chip containing the GPS receiver

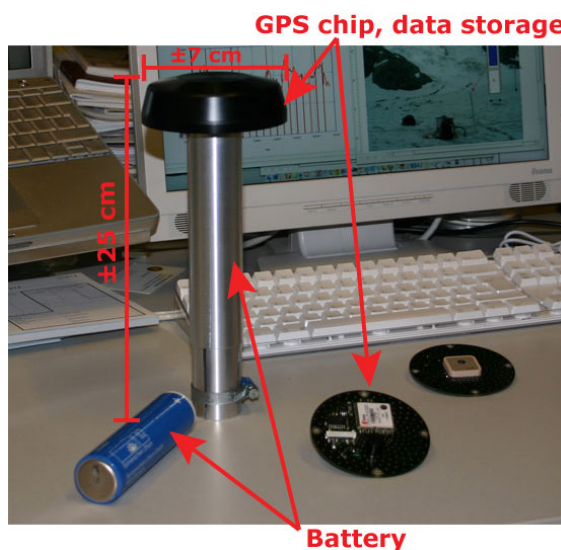
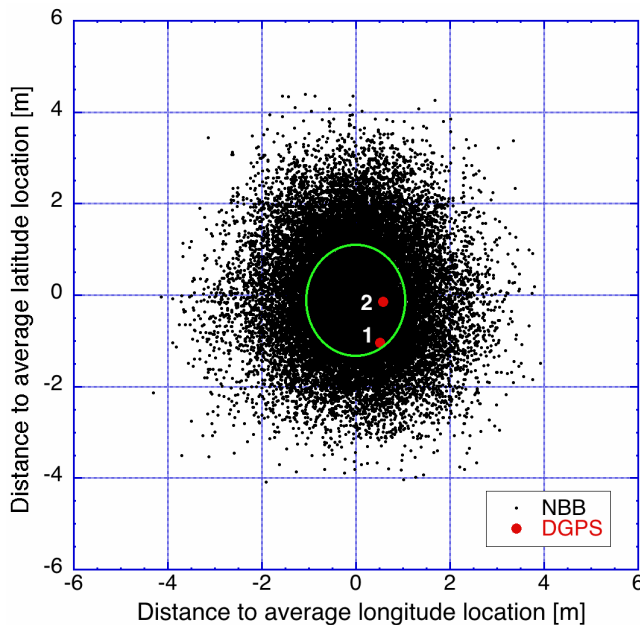

Figure 1. GPS unit.

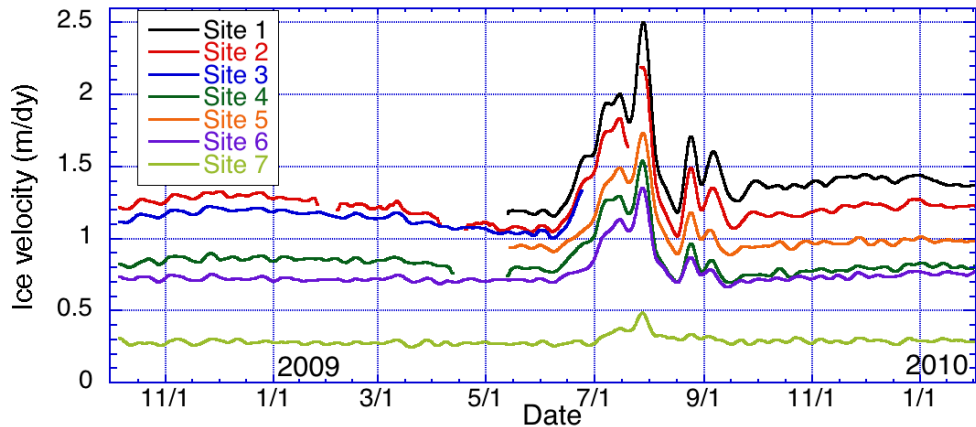

**Figure 2.** Scatter plot of three years of non-averaged data from a reference site on Svalbard (NBB). Observations are plot with respect to the average location, negative values denote the records to the south and/or west of the average position. The red dots indicate the location of the DGPS with respect to the averaged location, 1 = 2007, 2 = 2008. The green circle denotes one standard deviation of the non-averaged data.

and the data storage unit. The receiver uses 15 Ahr per year and when powered by one 3.6V Lithium battery can run for over one year without servicing. The sample time is between 1 to 3 h and all data is stored locally. More details can be found in [Den Ouden \*et al.\* \(2010\)](#). First test with the system were carried out in 2004 on Breidamerkurjökull, and first year round deployment was in 2005 on the Kangerlussuaq transect, Western Greenland of which results are presented in [Van de Wal \*et al.\* \(2008\)](#). At present, about 60 IMAU GPS units are operational worldwide.

### Accuracy

The IMAU GPS unit is a stand-alone single-frequency system. The accuracy of a single measurement of such a system is on the order of 13-23 m depending on ionospheric conditions (HSAT value, [USA Department of Defense, 2008](#)). A number of methods and models are available to improve the accuracy of this type of system ([King \*et al.\*, 2002](#)). However, in order to limit power consumption only time and positional information is stored and almost no in situ computations are carried out. Therefore, none of these corrections can be applied due to lack of information. As a result, the accuracy of our system is variable in space and time, largely determined by ionospheric conditions. [Figure 2](#) illustrates the accuracy of a reference system placed on solid rock on Svalbard. The standard deviation (std) in three years of data is 1.65 m, which is much better than the HSAT values given above. This is due to the sampling strategy in which for every measurement the system is turned on for 3 minutes until a stable signal is reached.



**Figure 3.** Scatter plot of three years of non-averaged data from a reference site on Svalbard (NBB). Observations are plot with respect to the average location, negative values denote the records to the south and/or west of the average position. The red dots indicate the location of the DGPS with respect to the averaged location, 1 = 2007, 2 = 2008. The green circle denotes one standard deviation of the non-averaged data.

Glaciers show a wide range of velocities from slow (order m/yr) to very fast flowing glaciers (order km/yr). To better distinguish signal from noise, especially for slower moving glaciers, the signal must be averaged. Unfortunately, this reduces the temporal resolution. The std in the averaged observation reduces with  $1/\sqrt{n}$  with  $n$  being the number of measurements in the running average. With a sample time of 1 hour, averaging over  $n = 168$  hours results in a reduction of the std to 0.20 m. As a result, applicability of this system is limited to faster flowing glaciers ( $> 30$  m/yr). An example of observed velocities after averaging is given in Figure 3.

## Challenges

Besides the accuracy of the system posing a limit to its applicability, the harsh environment on glaciers also provides challenges. Moisture is a major problem for all electronic equipment on glaciers. The housing of the unit is constructed such that fortunately no moisture problems are encountered. Furthermore, the system is not opened in the field for data collection ensuring that no moisture can enter the system in situ.

Ice formation around the instrument may cause the stake on which it is mounted to break, which may result in burial of the instrument. To prevent loss of the system through burial, a RECCO reflector is attached to the unit ([Link](#)). RECCO is a system used for finding and rescuing avalanche victims. The RECCO transmitter uses a directional radar signal to locate a RECCO reflector. It works up to 200 m through air and depending on moisture content of the snow up to 20 m through snow. Since using this system we found 5 units out of 6 that would otherwise be lost.

In very crevassed areas systems are placed using helicopters instead of snow mobiles or hiking. In order to ensure data collection, the IMAU GPS

are now equipped with Argos transmitters, broadcasting data every few days. Note that this type of IMAU GPS uses more than one 3.6V lithium battery.

## Conclusions

The IMAU GPS system is a very robust system with low power consumption. Main issue of this system is its accuracy (order 1.5 - 2 m). As a result averaging is necessary to improve signal to noise ratio limiting the temporal resolution to several days, and applicability of the system to faster flowing glaciers (> 30 m/yr). Recent developments include a type that transmits data using the Argos satellite system and applying DGPS techniques to improve the accuracy. As a side result, the RECCO has proven to be very useful in finding buried equipment.

## References

- Den Ouden, M., C. Reijmer, V. Pohjola, R. van de Wal, J. Oerlemans and W. Boot. 2010. Stand-alone single-frequency gps ice velocity observations on nordenskiöldbreen, svalbard. *The Cryosphere*, **4**, 593–604.
- King, M., S. Edwards and P. Clark. 2002. Precise point positioning: Breaking the monopoly of relative gps processing. *Engineering Surveying Showcase*, pages 40–41.
- RECCO Avalanche rescue technology. <http://www.recco.com>.
- United States Air Force. 1996. Navstar gps user equipment introduction. Techn. rep., United States Air Force.
- USA Department of Defence. 2008. Global positioning system standard positioning service performance standard. Techn. rep., Department of Defence, United States of America.
- Van de Wal, R., W. Boot, M. van den Broeke, C. Smeets, C. Reijmer, J. Donker and J. Oerlemans. 2008. Large and rapid melt-induced velocity changes in the ablation zone of the greenland ice sheet. *Science*, **321**, 111–113.
- Zwally, H., W. Abdalati, T. Herring, K. Larson, J. Saba and K. Steffen. 2002. Surface melt-induced acceleration of greenland ice-sheet flow. *Science*, **297**, 218–222.

# Recent technical developments at the IMAU: a new generation of AWS and wireless subglacial measurements

Paul Smeets, Wim Boot, Michiel van den Broeke, Roderik van de Wal

Institute for Marine and Atmospheric research Utrecht, Utrecht University, The Netherlands.

## Introduction

Two technical developments are presented: a new generation of AWS and a wireless subglacial measurement system. Both systems build on the experience of the IMAU in developing GPS systems (Den Ouden *et al.*, 2010). Combining methods to minimize energy consumption and wireless communication form the basis of the new systems described here.

## A new IMAU AWS

The current AWS design originates from the early nineties, and its success is for a large part based on the use of lithium batteries and Campbell dataloggers. Currently the IMAU operates 18 AWS on glaciers (Antarctica 9, Greenland 4, Norway 3, Svalbard 1, Switzerland 1). An AWS typically is powered by 96 lithium batteries for 3 years of continuous operation. The transportation rules for these batteries become increasingly strict and their cost price is high. Additionally, Campbell Scientific recently stopped producing the CR10X datalogger which is used in all IMAU AWS. In the light of these developments, the rising costs and problems with the uniformity and the operation and maintenance of an increasing number of AWS, the IMAU decided to start the development of a completely new type of AWS.

The core of the new AWS design is an IMAU developed logger unit that is customized to our requirements. Its main characteristics are minimal energy use, small size, wireless communication and easy handling. In Figure 1 the current and new AWS design are compared.

The logger unit is small (dims. 18x32x12 cm) and integrates the energy supply (2 batteries, a capacitor and a small solar panel), the datalogger, Bluetooth for wireless communication and ARGOS communication electronics. Furthermore, it includes sensors for temperature, humidity, pressure, GPS (time and position), tilt, compass and instrument height. As with the current AWS, ablation and possibly sub-surface temperatures are measured at a separate stake. The new AWS uses Bluetooth instead of a cable for the data transmission. In Figure 2 a schematic diagram of the logger unit and part of its internal components is shown.

A complete AWS of the new generation constitutes a logger unit, a Young wind vane, and a KIPP CNR4 radiation sensor all fixed to a single

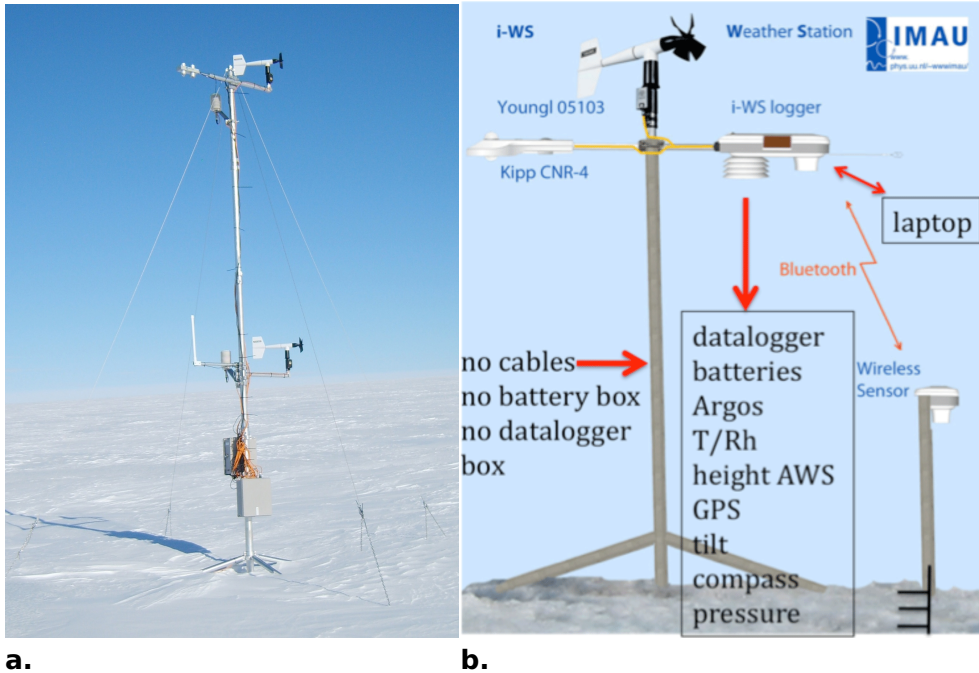
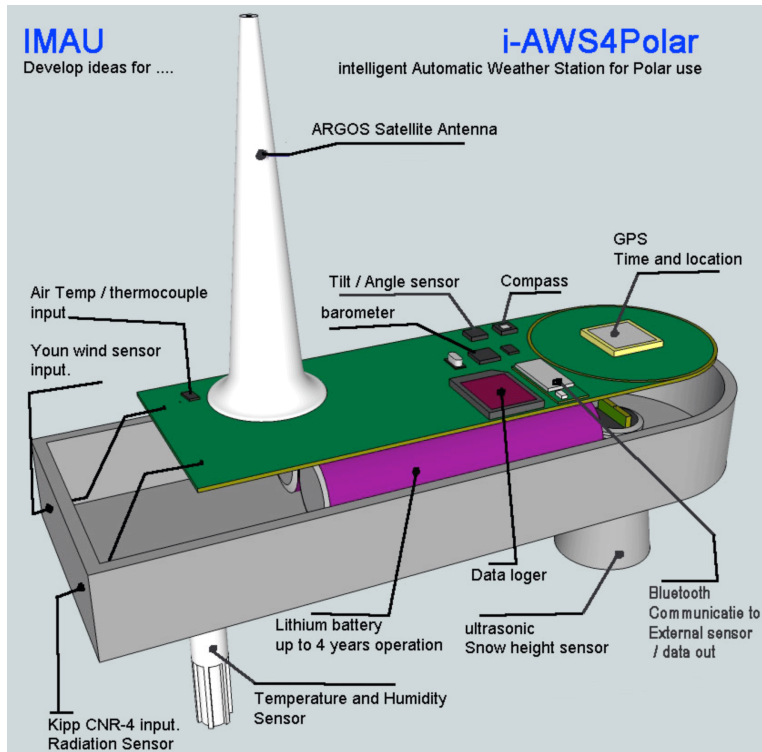

**Figure 1.** a) The current AWS design that is used in Greenland (two measurement heights). Close to the surface the datalogger and battery box are fixed to the mast while all instruments for wind speed/direction, temperature/humidity and radiation are fixed at the two mast extensions (2 and 5 m high). The lower mast extension also carries an antenna for ARGOS data transmission. b) The new AWS design has one mast extension at 4 m height carrying all instruments, cables, ARGOS antenna, datalogger and batteries. If needed, a second sensor arm can be attached.

mast extension (Fig. 1) that fits in a standard Explorer case. The new design maintains the currently used 4-legged foot with telescopic pole that is used for the current AWS. Replacement of the complete AWS instrumentation is therefore much faster and easier than with the current design, while Bluetooth allows wireless data transfer between the logger unit and e.g. a laptop. Fast sampling of wind speed and temperature (using an additional thermocouple) are also foreseen, allowing the derivation of turbulence fluxes using the variance method (De Bruin and Hartogensis, 2005). A field experiment is currently carried out to assess the quality of this method for use with AWS data.

### Current status of the new IMAU AWS

At the moment single logger components are tested and a complete version of the new logger is expected to become available in the spring of 2012, if funding is obtained. First tests are foreseen in the Netherlands and Switzerland (Morteratch Glacier).



**Figure 2.** Detailed schematic of the logger unit and its internal components.

## A wireless subglacial probe system for deep ice applications

Another technological development at IMAU concentrates on englacial measurements in ablation zones. A problem with this type of measurements is that the internal shearing may corrupt electrical cables preventing long term observations at depth. Here, we present the design and first results of a wireless subglacial probe system that is able to transmit data through at least 600 m thick ice without signal cables running from the instruments to the surface. The motivation to develop this type of system originated from the study of the role of surface melt water in the dynamics of ice sheets and ice caps. Melt water percolates in the snow and firn in the accumulation area, where it partly refreezes. In the ablation area, the meltwater partly runs off at the surface and partly reaches the glacier base through crevasses and moulins, where it has the potential to increase basal sliding via increased basal water pressure. Recently the role of melt water has been identified as influencing the motion of larger ice caps and even ice sheets in Iceland, Svalbard and Greenland (e.g. Zwally *et al.*, 2002; Van de Wal *et al.*, 2008; Benn *et al.*, 2009; Sundal *et al.*, 2011). At present, a lack of information on subglacial water pressure hampers a better fundamental understanding of this process and its importance for the long term evolution of the ice sheet.

The wireless system is designed to penetrate through thicker ice (up to



**Figure 3.** a) A probe and its internal components (the transmitter, lithium battery and a pressure sensor) and b) a probe attached to the 3 mm kevlar rope.

about 1000 m) than previous systems (Harrison *et al.*, 2004; Hart *et al.*, 2006). The receiver/datalogger system is mounted on a small 4-legged mast that stands freely on the ablating ice surface. This is in contrast to previous wireless systems which installed their receiver somewhat below the ice surface while it was connected via a serial/power cable to the datalogger at the ice surface to avoid signal losses occurring in the upper part of the glacier resulting from the presence of liquid water.

Figure 3 shows the internal components and the connection to the kevlar rope that is used to lower the wireless probes in a hole. The upper panel displays the custom made black housing of the probe and its internal components. The housing is composed of the technical plastic Delrin®. It has high mechanical strength and rigidity, excellent resistance to moisture and has a wide end-use temperature range. The housing of the prototype has an outer(inner) diameter of 50(40) mm, a length of 350 mm and was designed to resist 200 bar of pressure. The probe contains three main components (upper panel, Fig. 3) with, from left to right, the 100 mW transmitter working at a frequency of 30 MHz, a lithium battery (3.6 V, 35 Ah, Tadiran batteries), and a pressure transducer (working range 0-100 bar, maximum peak pressure 300 bar). The energy consumption of the wireless probe is minimized and continuous operation can be maintained for more than 5 years, while measuring and logging data every 2 hours. The



current prototype of the probe contains 1 sensor at a time but future versions are foreseen to include multiple sensors. The probe is attached to a 3 mm kevlar rope that is used to lower the probes in a hole (lower panel, Fig. 3). At the outer ends of the housing rope clamps enable easy fixation of a probe to the rope.

At the ice surface, an antenna configuration is fixed horizontally to a wooden/plastic frame. The antenna is connected to the receiver/datalogger system, which is powered by a pack of lithium batteries and mounted on a small 4-legged mast. Currently, one receiver/datalogger system is able to monitor 32 probes simultaneously. Each probe sends out a coded set of real time data at approximately every 3 minutes (each probe uses a slightly different time interval). Once every 2 hours the receiver starts to gather the data from all probes during 10 minutes.

The test experiment was conducted at site SHR along the K-transect at Russell glacier in South-West Greenland near Kangerlussuaq, just north of the Arctic Circle. The K-transect was established in 1990 by the IMAU and currently constitutes eight locations with mass balance and GPS measurements and three locations with AWS; the latter have been operational since August 2003 (Van de Wal *et al.*, 2005; Van den Broeke *et al.*, 2009a). Location SHR lies about 15 km from the front of Russell Glacier and was chosen because there the summer speed-up is the largest along the K-transect (Van de Wal *et al.*, 2008). The experiment combined the measurement of subglacial pressure, surface velocity and surface melt water production with best possible precision at hourly resolution.

Two holes were drilled with the hot water drill from the Alfred Wegener Institute (AWI, Bremerhaven, Germany), to the ice sheet bottom in the marginal ice zone, approximately 620 m deep. In one hole, a wireless pressure and tilt probe were lowered to the base of the glacier, while a temperature profile consisting of 23 probes was installed at a distance of 1.5, 5.5, 10.5, 15.5 m and ongoing at intervals of 25 m from the base. In the second hole a wired pressure/temperature probe was lowered to the base for reference. Five GPS receivers were operated at and around the drill site, together with an automatic weather station (AWS). First data were retrieved in August 2010 and at that time the wireless system was still operating as it was left in July, receiving data from 26 wireless probes. The second dataset was obtained in June 2011 and showed that the receiver battery was drained in February 2011, but that all wireless sensors were still operational. During this last visit, batteries were exchanged and we hope to capture the remaining part of the melt season.

### **First results from the wireless subglacial system**

Figure 4 shows the first results for the July-August 2010 campaign. We find good agreement between the timeseries of subglacial pressure measured by the wireless and wired systems. The absence of data gaps demonstrates that the wireless system is well capable of transmitting data continuously through at least 600 m thick ice, with only a limited number of

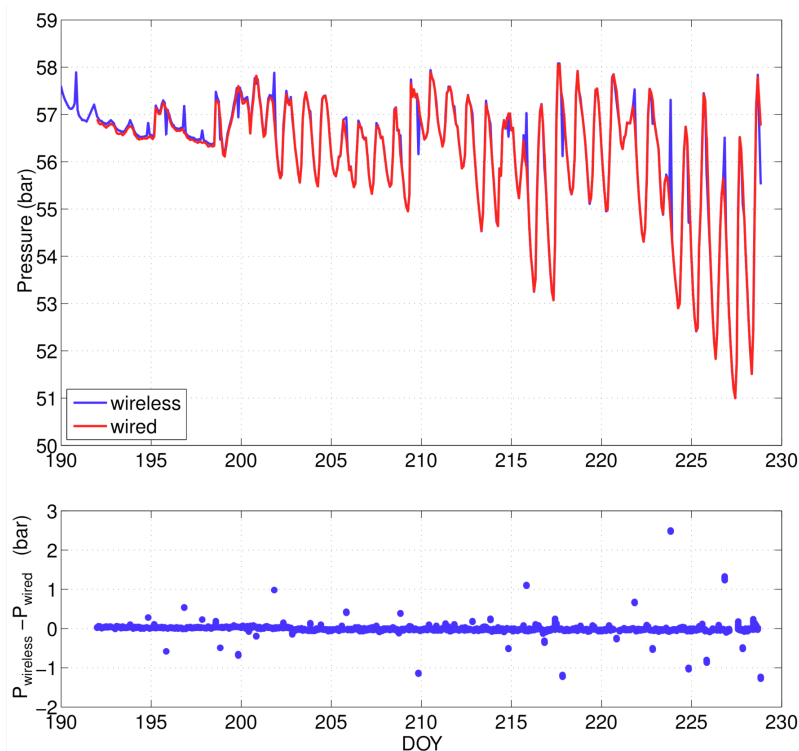

**Figure 4.** a) A probe and its internal components (the transmitter, lithium battery and a pressure sensor) and b) a probe attached to the 3 mm kevlar rope.

outliers. For a proper comparison, we only selected data that were simultaneously measured by both probes within a time window of 30 minutes. Hole 2 was approximately 22 m deeper than hole 1, and to correct for this we offset the wireless pressure data by +2.2 bar. The lower panel of Figure 4 shows the pressure difference; besides a few spikes in the wireless data set (less than 1%) the standard deviation of the differences between both timeseries is 0.2 bar including all spikes (or 0.05 bar excluding the most obvious spikes). The small random differences are probably to be explained by the subglacial pressure variations within the 30 min time window.

### Current status of the wireless subglacial system

Future experiments will involve testing a modified version of the wireless system with higher transmission power (i1000 mW transmitter and a 400 bar probe housing) in the 3000 m deep drill hole at the NEEM site in June 2011, to obtain a maximum depth range for the wireless system. Furthermore, we hope to capture the 2011 melt season at SHR with the currently installed wireless system, together with simultaneous measurements of the surface velocity by GPD measurements and surface energy balance from a nearby AWS.

## Acknowledgements

The development of the wireless probe system is part of research performed within ice2sea work package 2.2 and dedicated to the basal lubrication by surface melt. We acknowledge the ice2sea project, funded by the European Commission's 7th Framework Programme through grant number 226375, ice2sea manuscript number 037.

## References

- Benn, D., J. Gulley, A. Luckman, A. Adamek and P. Glowacki. 2009. Englacial drainage systems formed by hydrologically driven crevasse propagation. *J. Glaciol.*, **55**(191), 513–523.
- De Bruin, H. and O. Hartogensis. 2005. Variance method to determine turbulent fluxes of momentum and sensible heat in the stable atmospheric surface layer. *Boundary-Layer Meteorol.*, **392**, 116:385. DOI: 10.1007/s10546-004-1986-2.
- Den Ouden, M., C. Reijmer, V. Pohjola, R. van de Wal, J. Oerlemans and W. Boot. 2010. Stand-alone single-frequency gps ice velocity observations on nordenskiöldbreen, svalbard. *The Cryosphere*, **4**, 593–604.
- Harrison, W., M. Truffer, K. Echelmeyer, D. Pomraning, R. Abnett and K. Ruhkick. 2004. Probing the till beneath black rapids glacier, alaska, usa. *J. Glaciol.*, **50**, 608–614.
- Hart, J., K. Martinez, R. Ong, A. Riddoch, K. Rose and P. Padhy. 2006. A wireless multi-sensor subglacial probe: design and preliminary results. *J. Glaciol.*, **52**, 389–397.
- Sundal, A., A. Shepherd, P. Nienow, E. Hanna, S. Palmer and P. Huybrechts. 2011. Melt-induced speed-up of greenland ice sheet offset by efficient subglacial drainage. *Nature*, **469**, 521–524.
- Van de Wal, R., W. Greuell, M. van den Broeke, C. Reijmer and J. Oerlemans. 2005. Surface mass-balance observations and automatic weather station data along a transect near kangerlussuaq, west greenland. *Ann. Glaciol.*, **42**, 311–316.
- Van de Wal, R., W. Boot, M. van den Broeke, C. Smeets, C. Reijmer, J. Donker and J. Oerlemans. 2008. Large and rapid melt-induced velocity changes in the ablation zone of the greenland ice sheet. *Science*, **321**, 111–113.
- Van den Broeke, M., C. Smeets and J. Ettema. 2009a. Surface layer climate and turbulent exchange in the ablation zone of the west greenland ice sheet. *Int. J. Climatol.*, **29**(15), 2309–2323.
- Zwally, H., W. Abdalati, T. Herring, K. Larson, J. Saba and K. Steffen. 2002. Surface melt-induced acceleration of greenland ice-sheet flow. *Science*, **297**, 218–222.

# Using automatic weather station data to quantify snowmelt

Michiel van den Broeke, Paul Smeets, Carleen Reijmer, Wim Boot

Utrecht University, IMAU

## Motivation

Snowmelt constitutes an important part of the surface energy and mass balance of the ice sheets of Greenland and Antarctica. In Greenland, the entire ice sheet experiences occasional melt, as indicated by thin, isolated ice lenses in firn cores drilled at the highest part of the ice sheet and supported by regional atmospheric climate models (Ettema *et al.*, 2010). In Antarctica, melt is limited to the coastal areas, but is especially significant in the Antarctic Peninsula, where the melt season may last as long as three months (Tedesco and Monaghan, 2009). On both ice sheets, the largest fraction of the melt energy is invested in the melting of snow rather than ice. The reason is that the Greenland ablation zone is relatively narrow and constitutes less than 10% of the total surface area. In Antarctica, ablation areas form at locations where sublimation (not melt!) locally exceeds snowfall. These so-called blue ice areas constitute less than 1% of the total surface area and as a result, nearly all surface melt in Antarctica is due to snowmelt.

The energy associated with the melting of glacier ice can be deduced from surface height changes, obtained from re-measuring stakes that are fixed deep in the ice, or monitored continuously using sonic height rangiers (Van den Broeke *et al.*, 2011). The conversion from height change to melt energy is simple, because glacier ice has a density that is known to within 1% ( $910 \pm 10 \text{ kg m}^{-3}$ ). A correction must be made for the effect of mass transport by sublimation/deposition (riming), but usually this is a second order effect.

Snow height changes can be measured equally well, but the conversion to melt energy is much more problematic. The reason is that, apart from melting and sublimation/deposition, snow surface height is also influenced by erosion/deposition of blowing snow and densification of snow layers between the anchor point of the instrument and the surface. Even if one could be certain that melt is the only process affecting local snow height, the height change can only be converted to melt energy if the density of the surface snow is known. Surface snow density is hard to measure and, because no international standard exists for the depth to which surface snow should be sampled, it is an ill-defined quantity anyway.

Not being able to directly observe snowmelt energy constitutes an important problem in climate and surface mass balance research, because (regional) climate models calculate snowmelt energy (or melted snow mass,

which is equivalent), and thus require observed snowmelt energy (or mass) for model evaluation.

### Surface energy balance model

An indirect yet sufficiently accurate way to quantify snowmelt energy is to use a surface energy balance (SEB) model in combination with data of manned weather stations (MWS) or automatic weather stations (AWS). The SEB of a melting 'skin' layer of snow is given by:

$$M = SW_{net} + LW_{net} + SHF + LHF + G_s \quad [Wm^{-2}]$$

where  $M$  is melt energy,  $SW_{net}$  is absorbed (net) shortwave radiation,  $LW_{net}$  is net longwave radiation,  $SHF$  and  $LHF$  are the turbulent fluxes of sensible and latent heat and  $G_s$  is the subsurface (conductive) heat flux, evaluated at the surface. All terms are defined positive when directed towards the surface. To calculate  $G_s$ , a snow model that simulates snow temperatures and meltwater percolation/refreezing is required. To calculate  $SHF$  and  $LHF$  requires instrument height and surface momentum roughness ( $z_0$ ) to be known. The scalar roughness lengths for heat ( $z_h$ ) and moisture ( $z_q$ ) can then be calculated using the expressions of [Andreas \(1987\)](#), with the adjustments for rough ice surfaces of [Smeets and van den Broeke \(2008\)](#). If  $z_0$  varies significantly in time, its value can be obtained from two-level measurements of wind speed during neutral conditions ([Van den Broeke et al., 2009](#)).

For a sufficiently accurate determination of the SEB components, the MWS/AWS measurements should be of good quality and with few data gaps. Especially important is the availability of a complete series of radiation measurements. For use on AWS, the Kipp and Zonen CNR1 has proven to be a good choice; this sensor measures all four radiation components in a single housing, with sufficient accuracy once corrections have been applied for the relatively poor cosine response at low sun elevations. Being single-domed, the shortwave sensors are relatively insensitive to riming ([Van den Broeke et al., 2004](#)). For a more detailed description of the SEB solving technique and AWS sensors used in Greenland and Antarctica, we refer to [Van den Broeke et al. \(2011\)](#) and references therein.

### Example applications

Figure 1 shows two examples of the seasonal cycle of SEB components based on multiyear AWS data from Greenland (S9, 67°03' N, 48°14' W, 1520 masl, data period 1 Sep. 2003 - 31 Jul. 2010) and MWS data from Antarctica (Neumayer station, 70°39' S, 8°15' W, 40 masl, data period 1 Jan. 1995 - 31 Dec. 2007). Note the different scales on the vertical axes. Using daily-maintained, ventilated and heated radiation sensors, the MWS radiation data quality is clearly superior to that of the AWS data, and the calculated SEB components therefore more accurate. Yet, a direct comparison of observed and SEB-modelled surface temperature under non-melting conditions shows that the RMSE for the AWS in Greenland (0.97 K)

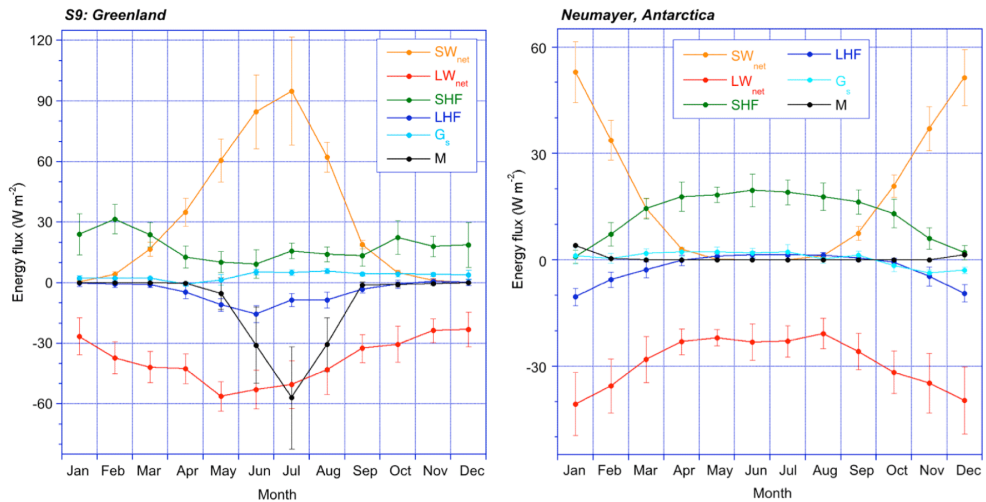

**Figure 1.** Seasonal cycle (based on monthly means) of SEB components at AWS S9 situated on the Greenland ice sheet (67°03' N, 48°14' W, 1520 m asl, data period 1 Sep. 2003 - 31 Jul. 2010) and Neumayer station in Antarctica (70°39' S, 8°15' W, 40 m asl, data period 1 Jan. 1995 - 31 Dec. 2007). Error bars indicate standard deviation of the monthly means. Note the difference in vertical scales.

is only marginally larger than for the MWS in Antarctica (0.73 K). Note that at both locations, the net radiation components to a large extent determine the SEB. Melting at the Greenland location lasts 3-4 months and peaks after the summer solstice in July, when the shortwave reflectivity (albedo) of the metamorphosed snow surface is lowest and  $SW_{net}$  as a result largest. At Neumayer, melt is marginal and peaks around the summer solstice in December and January, the months with the largest  $SW_{net}$  values. In spite of the very different climatological conditions and melt intensities, the SEB model generates realistic melt energy for both locations that can be used to evaluate regional climate models that are applied to the full ice sheets and/or satellite melt detection products. The great advantage of using an SEB model is that not only melt energy, but all individual SEB components are quantified, which is very valuable for the evaluation of physical processes that determine surface heat exchange in atmospheric models.

## References

- Andreas, E.. 1987. A theory for the scalar roughness and the scalar transfer coefficients over snow and sea ice. *Boundary-Layer Meteorol.*, **38**(1-2), 159–184.
- Ettema, J., M. van den Broeke, E. van Meijgaard and W. van de Berg. 2010. Climate of the greenland ice sheet using a high-resolution climate model – part 2: Near-surface climate and energy balance. *The Cryosphere*, **4**, 529–544.
- Smeets, C. and M. van den Broeke. 2008. The parameterisation of scalar transfer over rough ice. *Boundary-Layer Meteorol.*, **128**, 339–355.
- Tedesco, M. and A. Monaghan. 2009. An updated antarctic melt record through 2009 and its linkages to high-latitude and tropical variability. *Geophys. Res. Lett.*, **36**(L18502). Doi: 10.1029/2009GL039186.

- Van den Broeke, M., D. van As, C. Reijmer and R. van de Wal. 2004. Assessing and improving the quality of unattended radiation observations in antarctica. *J. Atmos. Oceanic Technol.*, **21**(9), 1417–1431.
- Van den Broeke, M., C. Smeets and J. Ettema. 2009. Surface layer climate and turbulent exchange in the ablation zone of the west greenland ice sheet. *Int. J. Climatol.*, **29**, 2309–2323. Doi: 10.1002/joc.1815.
- Van den Broeke, M., C. Smeets and R. van de Wal. 2011. The seasonal cycle and interannual variability of surface energy balance and melt in the ablation zone of the west greenland ice sheet. *The Cryosphere*, **5**, 377–390.

# GLACIOCLIM: a glacio-meteorological network to study the ablation processes over glaciers and snow covers

Patrick Wagon, Maxime Litt, Jean Emmanuel Sicart and Yves Lejeune

IRD (Institut de Recherche pour le Développement) / LTHE / LGGE  
38402 Saint Martin d'Hères Cedex, France  
(patrick@lgge.obs.ujf-grenoble.fr)

## GLACIOCLIM

Mountain glaciers are widely recognized as excellent indicators of climate change over recent centuries. Indeed, glacier mass variations can be used to assess climate warming over the 20<sup>th</sup> Century and possible anthropogenic influences. For more than 5 decades, the CNRS-LGGE<sup>1</sup> has been measuring the yearly volume changes of several glaciers over the French Alps. For almost two decades in the tropical Andes and one decade in Himalaya, the IRD<sup>2</sup> has monitored the mass balance and energy balance of various selected glaciers of Bolivia (since 1991), Ecuador (since 1995), India (since 2002) or Nepal (since 2007). In 2002, both institutions had the opportunity to join their efforts and to create an ORE<sup>3</sup>. This led to the project GLACIOCLIM<sup>4</sup> which is supported by IRD and local partners for its Andean and Asian parts and by CNRS-LGGE, INSU<sup>5</sup> and OSUG<sup>6</sup> for its Alpine part. An Antarctic part, supported by IPEV<sup>7</sup> has also been included since 2005 in this ORE in order to provide ground truth for climate models and remote sensing estimates. The aim of GLACIOCLIM is to complete, homogenize and perpetuate the glaciological and meteorological measurements conducted on selected glaciers or ice sheets representative of various climatological zones. Monitoring long-term trends of glaciers is of general interest for the study of climate change. By gathering mass balance measurements on glaciers together with a meteorological follow-up, GLACIOCLIM represents a unique framework in the world for studying the relationship between glaciers and climate or for understanding ablation processes. In this extended abstract, we first describe the structure of this observatory and then illustrate its scientific interest through an example of analyze of the turbulent fluxes over a seasonal snow cover in the French Alps.

---

<sup>1</sup>CNRS-LGGE: Centre National de la Recherche Scientifique - Laboratoire de Glaciologie et de Géophysique de l'Environnement

<sup>2</sup>IRD: Institut de Recherche pour le Développement - UR R032

<sup>3</sup>ORE: Observatory of Research in Environment

<sup>4</sup>GLACIOCLIM: the GLACIers, an Observatory of the CLIMate

<sup>5</sup>INSU: Institut National des Sciences de l'Univers

<sup>6</sup>OSUG: Observatoire des Sciences de l'Univers de Grenoble

<sup>7</sup>IPEV: Institut Polaire Paul Emile Victor



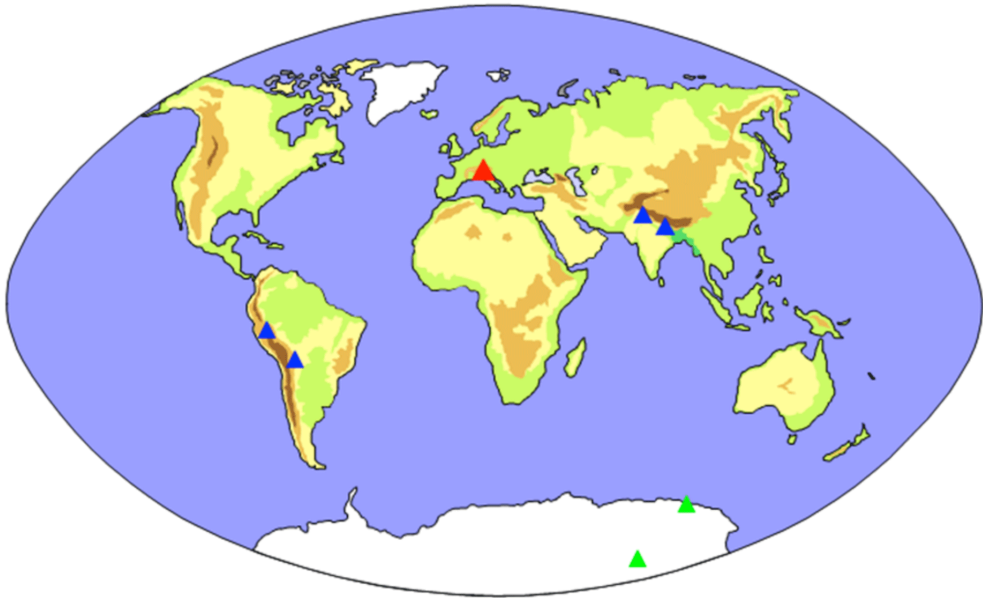

**Figure 1.** World map showing the location of the glaciers selected in GLACIOCLIM. Antizana (Ecuador, inner tropics), Zongo (Bolivia, outer tropics), Chhota Shigri (India, Himalaya) and Mera (Nepal, Himalaya) are monitored by IRD and local partners. Argentière, Saint Sorlin (and 3 others, Mer de Glace, Gébroulaz and Sarennes but only for glaciological measurements, French Alps, temperate region) are monitored by LGGE with the support of INSU and OSUG. Two sites are selected in Antarctica (polar regions) thanks to the logistical support of IPEV.

Figure 1 shows the glaciers which are part of GLACIOCLIM. These glaciers line up along a virtual climatic meridian from the Equator to the polar regions along which the inner and outer tropical, Asian monsoon, temperate and polar climates are represented. This observatory includes both long-term measurements (listed in Tab. 1) and short-term energy balance field campaigns, the purpose of which is to better understand the physical link between melting of glaciers and meteorological variables. Data are accessible on-line ([Link](#)).

### **Characterization of the boundary layer at Col de Porte, French Alps, and estimation of the turbulent fluxes.**

Energy exchange above snow and ice surfaces is a key issue in the understanding of the links between melting and climate. Turbulent fluxes of sensible and latent heat play a critical role in this balance. They are still poorly understood and difficult to measure in stable boundary layers, typically found above ice or snow surfaces. In the springs 2007, 2008 and 2009, meteorological measurements were performed above the seasonal snow cover at the Col de Porte, French Alps. The objective was to compute the turbulent fluxes from different methods in order to characterize their sensibility to data processing, evaluate their uncertainties, and understand their variability regarding to the atmospheric forcing. Two ap-

**Table 1.** Long-term measurements performed on glaciers in the framework of GLACIOCLIM.

<b>Glaciological measurements</b> (from 1 to 4 times a year, depending on the site)	<b>Meteorological measurements</b> (half-hourly means)
<ul style="list-style-type: none"> <li>• Ablation (stakes)</li> <li>• Accumulation (drilling)</li> <li>• Surface velocity (GPS)</li> <li>• Thickness variations (GPS)</li> <li>• Terminus mapping (GPS)</li> </ul>	<ul style="list-style-type: none"> <li>• Wind speed and direction, incident and reflected solar radiations, incoming and outgoing thermal radiations, ventilated air temperature and humidity, precipitation (AWS on nearby moraine)</li> <li>• Daily albedo (terrestrial photographs)</li> </ul>

proaches were applied: the aerodynamic profile and the eddy correlation methods. The measurements were performed within 3 meters above the snow surface. We used CSAT3 sonic anemometers and LICOR7500 hygrometers for the eddy correlation method, and a temperature and wind mast for the profile method. The "Edire" software (University of Edinburgh) was used to process the eddy correlation data. A specific processing list was derived for the local boundary layer conditions. We showed that the errors related to data processing were mostly due to: the spectral corrections of instrumental limitations, data filtering and divergences from the theoretical assumptions. A roughness length of  $10^{-1.5}$  m for wind was determined using both methods and a roughness length of  $10^{-5.5}$  m for temperature was found using the aerodynamic method. These values reflect the influence on the flow of roughness elements distinct from the snow surface. This is confirmed by a footprint calculation. The two methods were in rough agreement for the estimation of the turbulent fluxes. The aerodynamic method indicated slightly higher values in instable and neutral conditions. In stable conditions, the eddy correlation method indicated higher fluxes. This is attributed to energy losses by the low frequency data sampling in the aerodynamic method. Calculations of the latent heat flux were perturbed by non-stationary problems due to sensors path separation (wind and humidity). The latent heat fluxes derived from the aerodynamic method were not reliable due to the difficulty to measure very small humidity gradients. Measured fluxes were compared with those calculated by the snow model CROCUS. The parameterization of the roughness lengths in CROCUS agrees quite well with the two measurement methods. However, the model uses an empirical constant exchange coefficient for very stable conditions, which overestimate the fluxes in these flow conditions.

Figure 2 compares the turbulent fluxes derived from the aerodynamic bulk method, measured by eddy covariance and simulated by the snow model CROCUS. In neutral conditions, the three methods give similar results, especially for the sensible heat flux. It indicates that the theoretical requirements of the similarity theory are fulfilled in the boundary layer. Larger differences are observed for the latent heat flux. This may partly be due to measurement errors of the humidity.

In stable conditions, the differences between the methods are large.

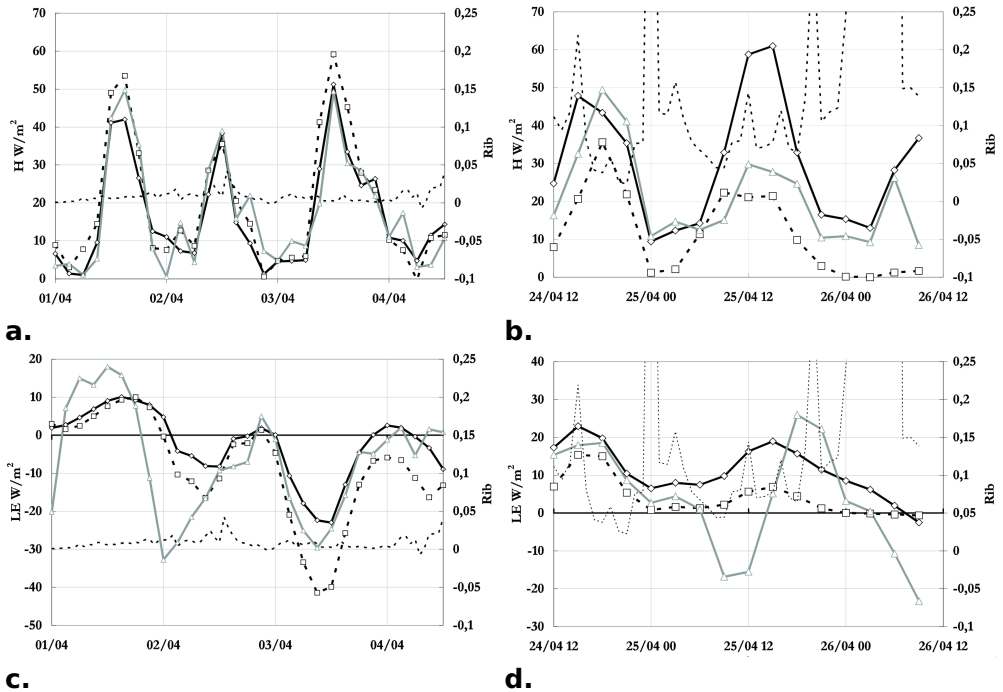

**Figure 2.** Turbulent fluxes of sensible (higher panels, a and b) and latent (lower panels, c and d) heat at Col de Porte for four days of neutral conditions (left panels, a and c) and four days of stable conditions (right panels, b and d). Black line shows the CROCUS simulations, Grey line shows the eddy correlation measurements, and black line + white squares show the bulk aerodynamic method. Dotted line (right Y-axis) shows the bulk Richardson number.

The eddy covariance fluxes generally are larger than the bulk aerodynamic fluxes. Various reasons can be invoked to explain this result. Turbulence may not scale to the local variables, which means that turbulence generated at large scales, from surrounding topography for instance, prevails on the local sources of turbulence. Brief turbulent bursts, measured by the eddy correlation system but not sampled by the slow response profile sensors, may significantly increase the fluxes. The transfer functions used in CROCUS do not agree with the eddy covariance fluxes.

## References

Online data at: <http://www-igge.obs.ujf-grenoble.fr/ServiceObs/index.htm>.

# Ice-mounted masts as platforms for micro-meteorological measurements on glaciers

Michael Winkler<sup>1</sup>, Rainer Prinz<sup>1</sup>, Lindsey Nicholson<sup>1</sup>, Nicolas Cullen<sup>2</sup>, Christophe Kinnard<sup>3</sup>

<sup>1</sup> Centre for Climate and Cryosphere, University of Innsbruck, Austria

<sup>2</sup> Department of Geography, University of Otago, New Zealand

<sup>3</sup> Centro de Estudios Avanzados en Zonas Áridas (CEAZA), La Serena, Chile

## Introduction

Automated measurements of meteorological variables on glaciers are necessary for surface energy and mass balance studies. Typically, the instruments are mounted on tripods that are placed on the ice without additional securing devices (e.g. guy wires). We take the opportunity here to describe an alternative method, that involves using segmented masts that are drilled vertically into ice or snow covered glacial surfaces (Fig. 1). The presented system (or a version of it) was tested at the following sites: Kersten Glacier (Kilimanjaro, TZ), Lewis Glacier (Mt. Kenya, KE), Glaciar Shallap (Cordillera Blanca, PE), Glaciar Cerro Tapado (Coquimbo region, CL), Glaciar Guanaco, Glaciar Ortigas, Glaciar Torre Toro (all 3 sites Atacama region, CL), Brewster Glacier (NZ), and at various sites in Greenland.

## Ice-mounted segmented mast design

The masts consist of aluminium (or steel) tube segments, each ca. 1-1.5 m long (**L** in Fig. 1A) with an outer diameter of ca. 50 mm and a wall thickness of ca. 4 mm. The segments are connected to each other through ca. 20-30 cm tubes with outer diameters equal to the inner diameter of the segments. They are fixed to both consecutive segments by high quality countersunk-head screws (Fig. 1B).

The combined mast is put into a hole drilled by an ice auger<sup>1</sup> or steam drill. The depth of the bore hole (**L** in Fig. 1A) very much depends on the ablation rate between consecutive maintenance visits; at least 1.5 m of mast should always be encased by ice. It is valuable to drill a second mast (Fig. 1A) to avoid turning of the whole station that can e.g. be caused by wind in the case that the mast is temporarily not frozen into the host ice and to block the bottom ends of the tube with a plug to prevent the mast from sinking into the ice under its own weight (Fig. 1C).

If a standard weather station tower must be used, the uppermost tube of the segmented mast can be equipped with a plate on top of which the standard mast can be mounted (Fig. 1E). This has proved to be a stable structure, but care should be taken concerning the color and size of the

---

<sup>1</sup>48 mm outer diameter masts work e.g. perfectly with 51 mm Kovacs® ice augers.

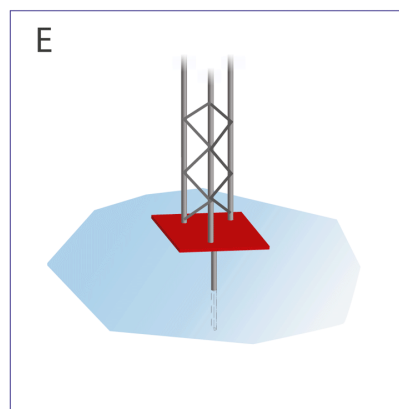
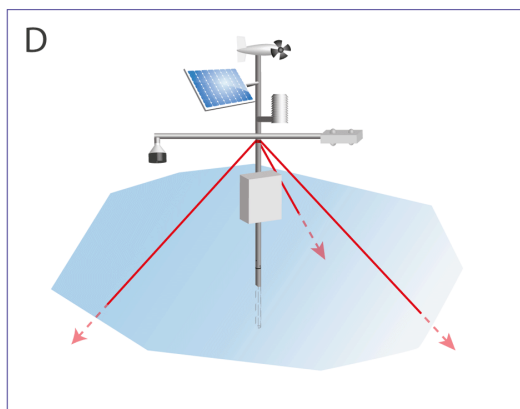
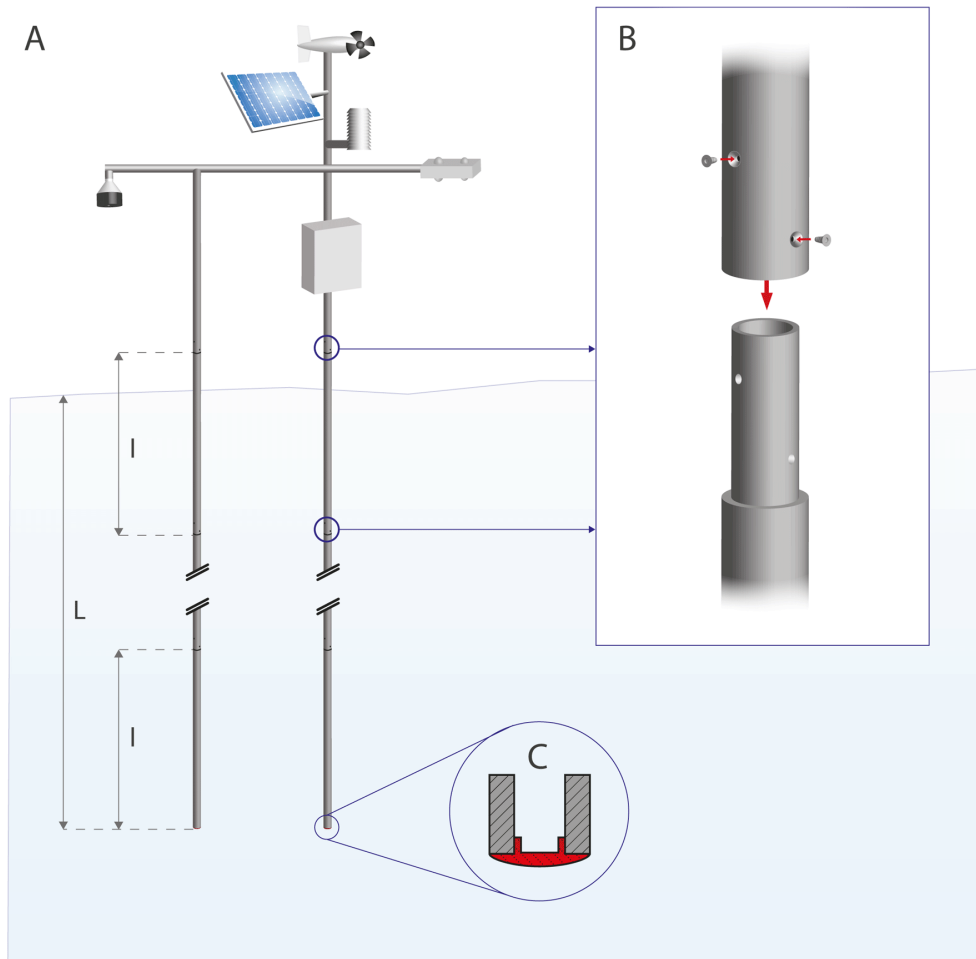

**Figure 1.** Segmented mast drilled vertical into the ice.

mounting plate, to minimise the influence of the plate on the meteorological measurements made. Additionally, the (single) mast can be braced with guy wires (Fig. 1D). A good way to fix the wires is by drilling holes in extension of the wires, plunging the wires into the holes and partly filling the holes with water. After the water is frozen, the wires can be tautened and the holes can be filled up completely. This guy line style was more successful than guy lines on traditional peg anchors as the pegs melt out and regular visits are needed to tension the wires correctly. Incorrectly tensioned guy lines can often be the cause of rather than the cure for station tilting!

### **Advantages of the ice-mounted segmented mast system**

1. The mast stays vertical assuring levelled sensors, a necessary requirement especially for measuring radiative fluxes, wind speed and wind direction. Tilt due to ice flow was never experienced by the authors but could be an issue on fast flowing, shallow glaciers. Particularly, over rough and rapidly changing glacier surfaces, tripod masts can become tilted or even fall over. Corrections can be made using inclinometers but uncertainties remain.
2. There is no need for a separate construction carrying the sonic sensor that measures ablation. When tripod masts are used there always has to be a separate construction drilled into the ice where the sonic ranger is mounted on. In case the ice-mounted construction can be prevented from melting into the ice, it makes a second mast superfluous (and also the messy cables between the two constructions).

Three more positive attributes of the drilled-in mast are that (i) manufacturing is cheap and easy and can be done by any skilled craftsmen even in developing countries, (ii) the segmented design allows quick extension or shortening of the mast according to accumulation or ablation situations without demounting the sensors, and (iii) dividing the mast's load (about 12 kg at 6 m length for the aluminium construction) to several field personal allows alpine style expeditions that access remote areas by foot to be carried out.

### **Restrictions of and recommendations for the ice-mounted segmented mast system**

There is only one disadvantage of the described system (compared to the usage of a tripod mast) that directly affects the measurement quality. Ablation continuously changes the height of the sensors above the ice surface, which means that data from different periods cannot necessarily be compared to each other. However, the sonic sensor provides height data for correction. All the other restrictions mentioned in the following are technical ones.

Mast segment connections differing from Figure 1B were also tried, with moderate success. E.g. tubes with threads that can be screwed onto each

other turned out to be weak and difficult to handle. The connection presented in Figure 1B actually strengthens the junction between two tube segments. Still, there are also problems with the Figure 1B - solution because the screws can break during opening because of the cold and from corrosion. It is suggested to use only two high quality screws per connection.

The drilled-in mast systems can only be applied at sites where the amount of mass turn over and the maintenance interval fit together, e.g. at sites with low mass turn over or at frequently visited glaciers. A second mast pole (or even a third, see Jarosch et al. "A versatile tower platform for glacier instrumentation: GPS and Eddy Covariance Measurements" in this issue) not only prevents rotation of a station but also gives it more stability (Fig. 1A). More than one mast can also be helpful on highly penitented glacier surfaces where unpredictable and locally high rates of surface lowering can cause the masts to melt out earlier than predicted.

As a rule of thumb, the weather station's center of gravity should never be more than 3 m above the ice surface and the mast should always be deeper in the ice than one tube segment length (at least 1.5 m). Guy wires avoid failures of the system during strong winds (Fig. 1D), but in most of the locations this mast type has been deployed in these were not necessary, and instead, at sites that are expected to experience high winds simply increasing the diameter of the mast is sufficient to resist high winds.

# Notes on AWS Measurements on the Kahiltna Glacier, Central Alaska Range, and a Simple Floating Temperature Stand Design

Joanna Young<sup>1</sup>, Anthony Arendt<sup>1</sup> and John Hulth<sup>2</sup>

<sup>1</sup> Geophysical Institute, University of Alaska Fairbanks, PO Box 757320, Fairbanks, Alaska 99775-7320, USA.

E-mail: joanna.young@gi.alaska.edu, arendta@gi.alaska.edu

<sup>2</sup> Department of Mathematical Sciences and Technology, Norwegian University of Life Sciences, PO Box 5003, NO-1432 Ås, Norway.

E-mail: john.hulth@umb.no

## Introduction

In the Central Alaska Range in Subarctic Alaska, a highly glaciated but sparsely monitored mountain range, the Kahiltna Glacier is one of few glaciers with a legacy of long-term observations. The U.S. National Park Service has maintained a single index site near the equilibrium line altitude for the past 20 years, providing annual measurements of net mass balance at that location (Mayo, 2001). With the goal of leveraging these records, an extended campaign of mass balance and meteorological field measurements forms part of a new and ongoing study to model the glacier-wide mass balance of Kahiltna Glacier. In 2010, in addition to mass balance measurements, a network of floating air temperature and relative humidity (RH) sensors was installed at five elevations during the melt season, and a fixed Automated Weather Station (AWS) with snow temperature, sonic ranger, and air temperature sensors was deployed on the lower ablation area throughout the winter months. As of June 2011, repeat measurements of air temperature and humidity were again underway, and an additional floating tripod AWS was deployed both to better characterize the local climate during the melt period, and to continuously monitor surface melt with a linear displacement - or draw-wire - sensor. Although the campaign to date has been quite successful, the inherent challenges of working in a glacial environment have imparted some useful lessons. In particular, given that characterizing local lapse rates is of key importance to melt modeling, adjustments to the design of floating temperature stands will be especially helpful for future work.

## Field Site

With a surface area of 522 km<sup>2</sup>, a length of 70 km, and a range of altitudes between 275 - 6090 m above sea level, the Kahiltna Glacier is the largest within the Central Alaska Range. It is not characterized as surge-type, as are many of the other glaciers in the range. It is also one of the most logistically accessible glaciers in the range, as fixed-wing aircraft frequently



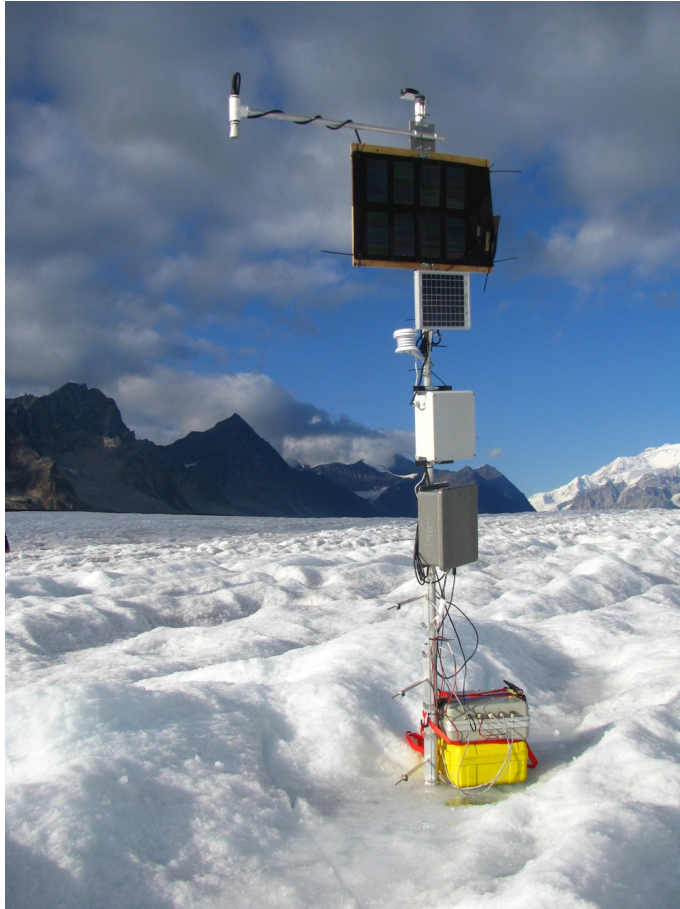

**Figure 1.** Winter AWS deployed in 2010/2011. Sensors are mounted on a fixed mast.

transport climbers to its southeast fork. Together with the long-term National Park Service mass balance site record, these characteristics - a wide range of altitudes, non-surge-type behaviour, and relative ease of access - make the Kahiltna Glacier an ideal location for expanding existing measurements in order to reconstruct glacier-wide mass balance.

### **Measurements and Different AWS Configurations**

To characterize temperature gradients on the glacier, five air temperature/RH sensors were installed in 2010 on the ablation area centerline between 880 - 1440 m in elevation, affixed to mass balance stakes.

The fixed AWS installed for winter 2010/2011 (Fig. 1) was positioned at  $62^{\circ}45'35.30''$  N and  $151^{\circ}18'26.51''$  E, at 1280 m elevation. On a 1" aluminum mast drilled 3 m into the ice surface, three resistance thermometers were affixed at 0.15 m, 0.50 m and 0.85 m above the ice surface to measure snow temperatures. On a horizontal cross-arm, a low-cost

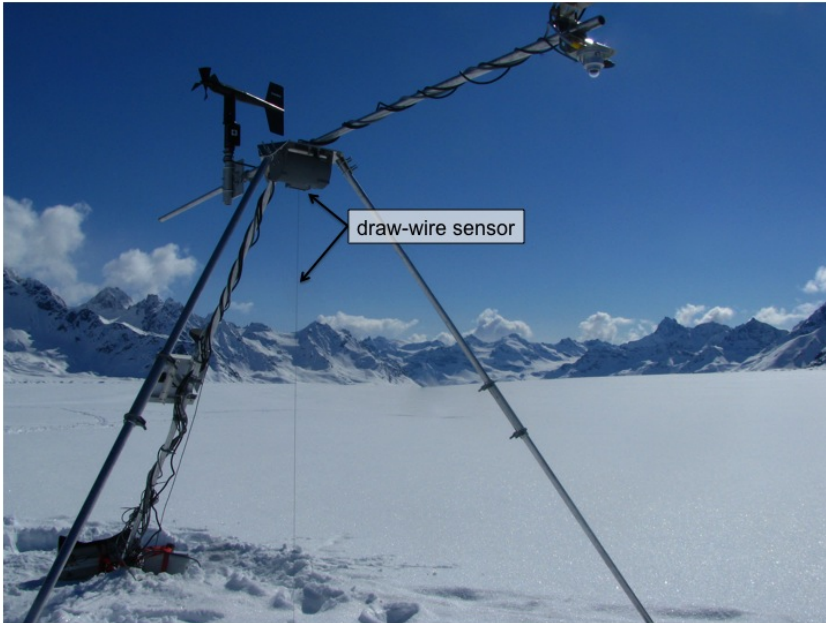

**Figure 2.** Summer AWS deployed in spring 2011. Sensors are mounted on a floating tetrahedron frame, which accommodates the draw-wire sensor.

custom-built sonic ranger measured snow accumulation rates. Air temperature and relative humidity were also recorded.

The 2011 summer AWS (Fig. 2), deployed at the same location, is a floating tetrahedron frame designed especially to accommodate a draw-wire sensor. The draw-wire has been drilled and frozen into the ice, and delivers a linear displacement measurement as the wire recoils. This enables continuous monitoring of glacier melt at high precision and temporal resolution (Hulth, 2010). Other measurements include incoming and reflected shortwave radiation, wind speed and direction, air temperature and humidity, and two-axis tilt. Data is telemetered via satellite, using a SolarStream wireless data transmitter.

### **Floating Temperature Sensors**

In order to accurately determine local lapse rates, air temperature measurements were made at five different elevations along the ablation area centerline. Given that snow/ice surfaces generate strong vertical temperature gradients, particularly in the summer (Oerlemans, 2010), floating temperature stands were designed to maintain sensors at a constant height above the glacier surface. In 2010, these stands were built using 1-1/4" PVC sleeves fitted over existing 1" aluminum mass balance stakes; the former was meant to freely slide down the latter, as the glacier surface lowered. The stands also had square PVC bases, approximately 30 x 30 cm, which were intended to minimize melting into the snow or ice. Unfortu-

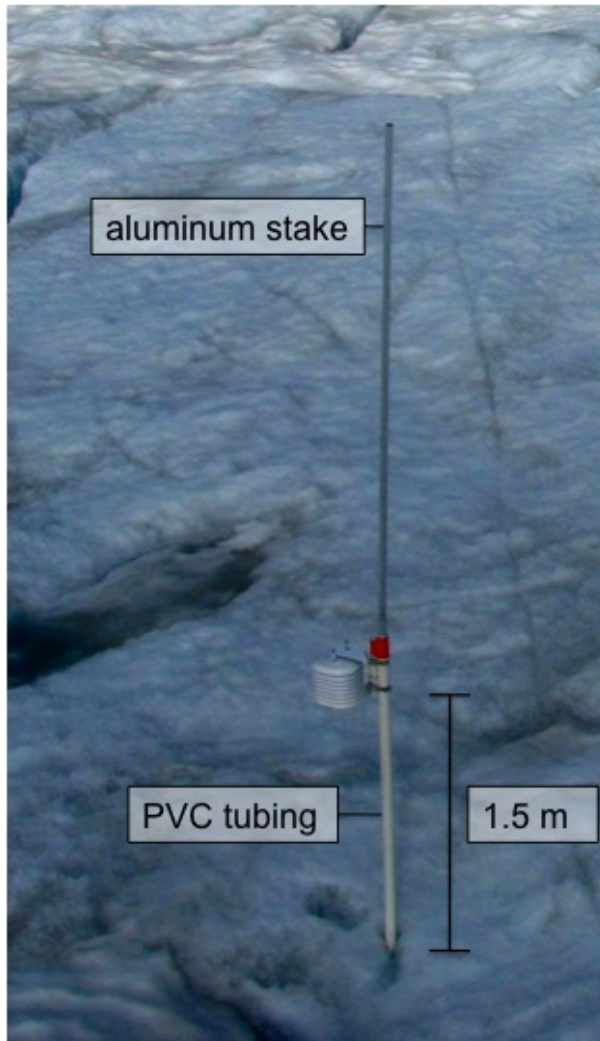

**Figure 3.** Successful floating temperature stand design. Radiation shield is mounted to a PVC sleeve that is fitted around an existing aluminum ablation stake.

nately, this initial design did not succeed. Rather than slide down, the PVC sleeves became lodged on the aluminum stakes, either resulting in air temperature readings at significant heights above the glacier surface, or in the bending or breaking of the aluminum stakes under the top-heavy weight of the sensors and stands.

Though the exact reason of the failure is unknown (i.e. whether the sensors became lodged due to mechanical friction, or due to ice between the PVC and aluminum), two key adjustments were made to the design when re-installing the sensors in 2011. First, a 1-1/2" PVC sleeve was used in place of the smaller variety, to allow significantly more room for ther-

mal expansion of both the PVC and aluminum in summer temperatures. Second, the PVC base was completely omitted on the second design. It is thought that the base may have contributed too much weight near the bottom of the stand, effectively forcing a point of contact between the PVC and aluminum, thereby pinching itself into place if the stand leaned even slightly. Regardless, it seems that simplicity is the key to a successful design in this case. The new stands, pictured in Figure 3, do experience some melting in, but are currently floating and recording fixed-height air temperatures effectively at five different elevations every ten minutes.

It is our experience that a simple, low-cost floating temperature stand design can be quite effective at capturing fixed-height air temperatures, easily providing valuable information for helping determine local lapse rates for melt modeling purposes.

### **Acknowledgements**

We gratefully acknowledge financial support from the Geophysical Institute, National Park Service George Melendez Wright Fellowship and Inventory & Monitoring Funding, and University of Alaska Center for Global Change. Indispensable field assistance has been provided by Michael Loso, Sam Herreid, Andy Aschwanden, Alessio Gusmeroli, Rob Burrows and Guy Adema.

### **References**

- Hulth, J.. 2010. Using a draw-wire sensor to continuously monitor glacier melt. *J. Glaciol.*, **56**(199), 922–924.
- Mayo, L.. 2001. Manual for monitoring glaciers at denali national park, alaska, using the index site method. Technical report, National Park Service.
- Oerlemans, J.. 2010. *The microclimate of valley glaciers*. Igitur, Utrecht Publishing & Archiving Services. 138. pp.